

Biosafety Cabinet Management Beyond The Basics





Table of Contents

Part I - General Guidance

Creating a culture of safety with Sean Kaufman	2
BSCs & fume hoods: What's the difference	8
Differences between American and European BSCs	12

Part II - Class II BSC Type Selection

BSC selection guide	14
To B2 or not to B2? That is no longer the question	18
CETA guide on Type B2 BSCs	22
Type C1, the right compounding BSC	24
Type C1 case study	27

Part III - Use and Accessorizing

4 reasons not to use open flames in BSCs	32
Best practices if a flame is needed	34
UV light use: The good, the bad and the ugly	36
9 things to know before installing an aspiration system	38

When it counts, count on us.

Labconco has been protecting people since 1925. We made our first laminar flow biohazard cabinet, the predecessor to the modern biosafety cabinet, in 1976. We've accumulated a lot of expertise and knowledge over the years. This book is a compilation of articles we think you'll find helpful if your work involves biological safety.



LABCONCO[®]

Creating a culture of safety with Sean Kaufman

Safety in the workplace is important regardless where you clock in every day. It's especially important to master when your work environment regularly contains hazardous particulates, harmful chemical vapors or radionuclides.

Even basic microbiological work has some associated risks. As oftentimes, it is not only necessary to protect the person sitting at the face of the cabinet but the science taking place inside on the work surface. It's with this eye toward protection that labs have rightfully turned to using biosafety cabinets (BSCs). This allows their technicians to properly and safely handle agents

that require Biosafety Level (BSL) 1-3 containment. That just scratches the surface, so we decided to dig a little deeper. We got the input of an outside industry expert to talk about how to create a culture of safety in labs, and how that relates to leadership.

That expert is Sean Kaufman, CEO of [Behavioral-Based Improvement Solutions](#). Sean's approach to the biosafety industry is truly safety-centric, and his knowledge has been called upon in high profile circumstances, including the 2001 Anthrax attacks and SARS outbreak.



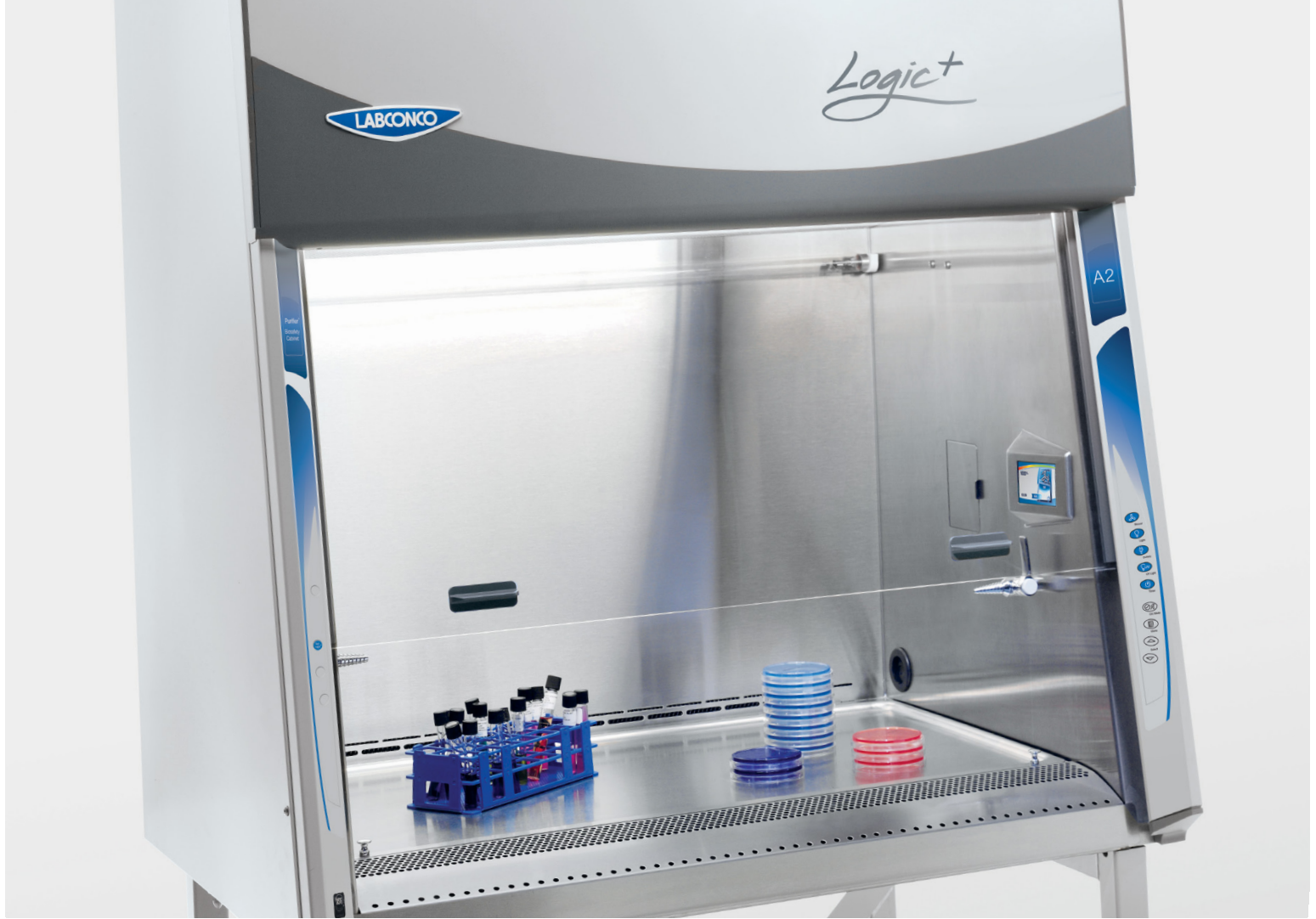

He has testified before Congress about infectious diseases. In 2014 he prepared the clinical staff at Emory Healthcare to respond to the first cases of Ebola on American soil. He then traveled to Nigeria and Liberia to prepare healthcare workers there to do the same.

Sean knows his stuff when it comes to biosafety. While his background is diverse, his message is simple: **safety matters**. We jumped at the chance to ask him a few detailed questions. Read on to learn how to create a culture of safety and why it's important.

Q & A with Sean Kaufman

Q: To start, can you describe a little bit of what you do?

A: I'm a behavioral psychologist focusing on infectious disease. Biosafety cabinets are very vital pieces of equipment but I focus on human behavior with and around them. You can spend thousands and thousands of dollars on a cabinet, but all the control can be negated in an instant with inappropriate behavior. I don't think the need for biosafety cabinets is any longer debated. One, they work. Two, they're efficient. Three, they're clean.



They're one of the best engineering controls we have in biosafety today. There are lots of complexities, but the workforce needs consistent investment in preparing them to effectively work in a cabinet—that's where I'm an advocate.

Q: Let's start dissecting those complexities. There are so many considerations when it comes to biosafety cabinet selection. How do you begin to conduct risk assessments, and why are they important?

A: That's a big question. When you look at a biosafety cabinet, the first and most basic thing you have to do is determine what you're going to be using it for. Then, decide how much workspace you need.

Ask yourself a few questions

- Are you going to be working with animals?
- What type of connection does your science require—are we talking recirculated A2 or thimble connected A2?
- Maybe you'll need a fully ducted B?

From a big picture perspective, we look to make sure the cabinet is certified, it is functioning properly and it passes a smoke test. If all those are in check and you've chosen the appropriate equipment, the biosafety engineering aspect has been done for you. Now you must operate safely within the enclosure.

Q: So, after selecting a biosafety cabinet, what comes next?

A: It's absolutely critical to train employees because they are the human interface of the biosafety cabinet, of that engineering control. Leaders need to train them how to choose appropriate personal protective equipment and develop standard operating procedures (SOPs) that answer real questions.

How do we set things up and break them down? In my opinion, by the way, the cabinet should be broken down and cleaned at the end of each night.

- What type of disinfectant are we using?
- How are we going to deal with corrosives?
- Are we working from clean to dirty?

The risk assessment list goes on and on, but having effective, tested and validated SOPs is critical throughout the life of the cabinet. When there are standard, easy to follow checklists in place for routine operations, some of those processes can be streamlined and the risks minimized.

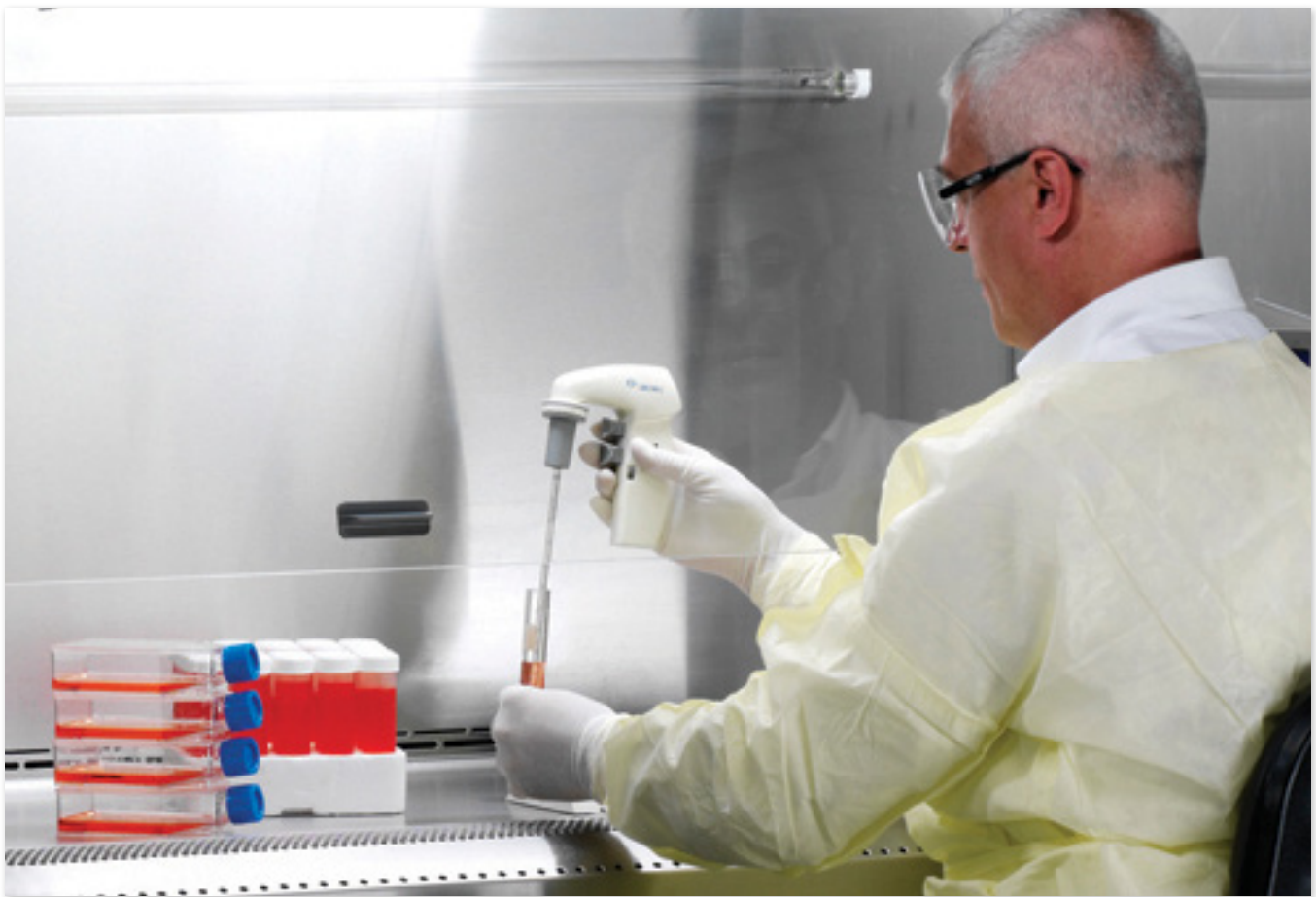

Q: As a behavioral psychologist, I think you're more qualified than anyone to answer this next question: Do you feel ergonomics play a role in safety in the lab?
A: Absolutely—but I have my own philosophy on that.

Leaders do three things. They prepare the workforce. They protect the workforce and they promote the workforce. When you look at the words 'prepare the workforce,' preparing means that they give the workforce the resources they need to do the job and to do it well. That's where good biosafety cabinet ergonomics come in.

These technicians are dealing with long hours at the bench, and you have to consider posture, arm position and a number of other behaviors that can affect how safe the work actually is. Adequate preparedness is critical in the workforce, and that's a leadership responsibility.

Q: Can you explain in greater depth the role of ideal leadership in the lab and how that relates to safety?

A: To me, biosafety cabinets are phenomenal engineering devices. However, the minute they come in contact with a human exhibiting human behaviors,

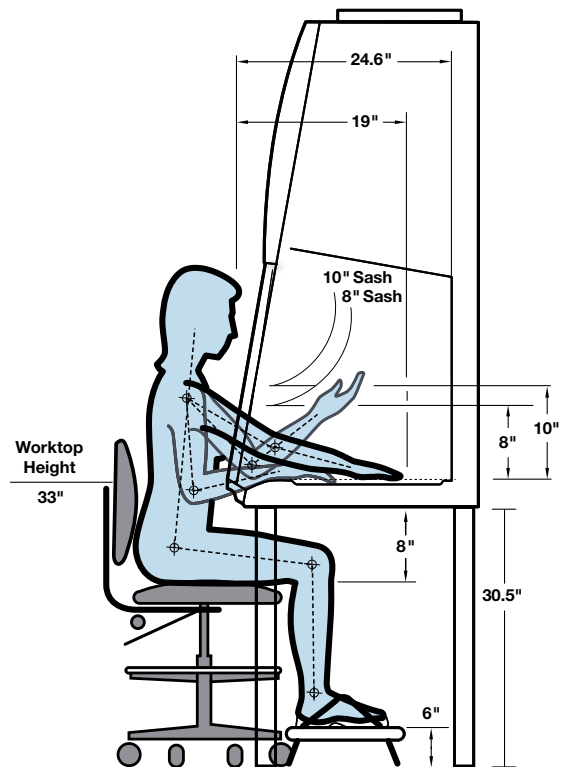
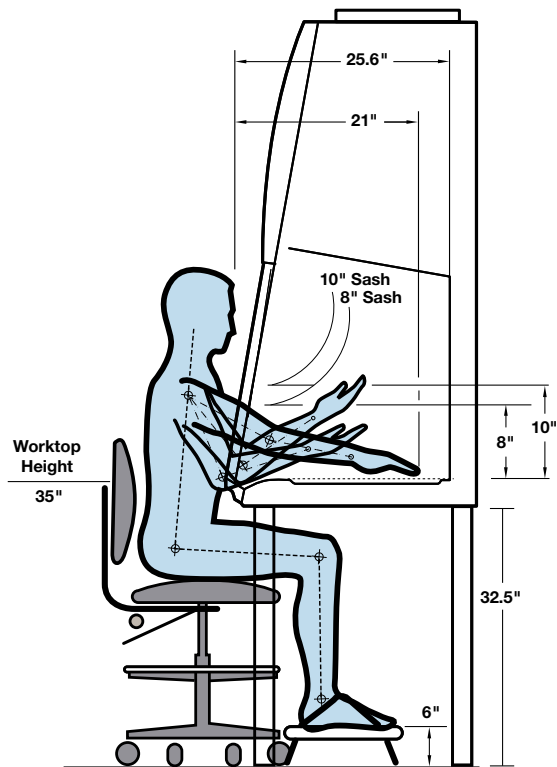

that person better be trained or the cabinet could risk losing its protectiveness. Again, that's a leadership thing. You can't just give someone a biosafety cabinet and say, 'go work.' You have to train them how to use it. Some technicians tend to over-rely on the engineering aspects of the cabinet. It's great that they're working in them, but they might botch the glove removal process or become lax at disinfecting. That's how we have instances of individuals coming out of biosafety

cabinets and contaminating other areas of their labs. The workforce is supposed to follow some very clear expectations. Even if they were to follow all of them, leadership still has a responsibility to the workforce. Guidelines and policies bring us together, but being together and doing together are very different things. Everyone has to be on-board with safety in order for it to work, and that starts at the top.



Sean Kaufman spoke before Congress on safety in the lab as it pertains to the anthrax incident of June 2014 at the Center for Disease Control.

BSCs & fume hoods: What's the difference

Although they're both sometimes referred to as "hoods," biosafety cabinets (BSCs) and fume hoods are two entirely different categories of lab equipment. Both are designed and built to contain hazards associated with science, but they differ in terms of the precise type(s) of protection provided, airflow and suitable applications.

Fume hoods are ventilated enclosures that remove chemical fumes and vapors from the lab, providing personnel protection only. Enclosures for life sciences utilize HEPA filters and directional airflow to provide environmental, personnel and/or product protection.

Both categories can recirculate or exhaust filtered air, depending on your process. While only a subset of life science enclosures, BSCs, are suitable for work with hazardous particulates like bacteria, viruses, and hazardous drugs.

If tasked with selecting an enclosure for a lab, below are some common points for consideration.

Note that improper selection or use of equipment can yield significant consequences for health, safety and operation/function of the lab (and its ventilation system). Always consult your safety officials for recommendations based on your specific processes.

Protection

Knowing what type of protection you will require is the first step in selecting the proper lab enclosure. BSCs provide environmental, personnel and product protection from hazardous airborne particulates. Clean benches create a sterile work zone for 'fragile' material manipulations. Fume hoods provide only personnel protection from hazardous chemical fumes and gases.

FUME HOOD BEST PRACTICES

Proper and undisturbed airflow is key to a safe and efficient work environment. Do not store large equipment inside the hood or do anything that could disrupt the movement of air. Never put your head inside the hood and keep the sash closed when not in active use.



Protector® XStream® Chemical Fume Hood

Fume Hoods: Airflow

Because fume hoods handle hazardous chemicals (see applications on page 10), air is drawn past the operator at the front of the equipment. The air passes through the opening and across the work surface. Finally it travels through the ductwork before being released to the outside atmosphere.

Biosafety Cabinets: Airflow

All three classes of BSCs have one benefit in common: operator safety from hazardous aerosolized/particulate materials.

1. In a **Class I**, air is drawn away from the operator, across the work surface, through a HEPA filter, and either returned to the lab or vented to the atmosphere.

2. In a **Class II**, intake air is drawn safely around the operator, sterile air flows downward into the work zone and exhaust air is HEPA filtered before it is either recirculated into the lab or released into the atmosphere.

3. Class III BSCs are work benches that utilize a complete physical barrier to contain hazardous work. Air enters through a single HEPA filter and is exhausted through redundant HEPA filters before being physically or chemically treated on its way to the atmosphere.



Purifier® Logic®+ Biosafety Cabinet

Class III BSCs can accommodate BSL 4 agents. Class II BSCs can accommodate BSL 4 applications with proper personnel protective equipment.

Fume Hoods: Applications

Chemical fume hoods can be used to handle:

- Odorous materials
- Toxic gases
- Reactive materials
- Chemicals that can spatter
- Carcinogens
- Flammables
- Other toxic and volatile materials

Biosafety Cabinets: Applications

BSCs provide a safe environment for research involving infectious microorganisms or other hazardous particulates. Depending on the type of cabinet, these enclosures are suitable for use with agents requiring containment in conjunction with BSLs 1, 2 or 3.

Fume Hoods: Variations

By-pass chemical fume hoods are the most common type, operating at a constant air volume. Auxiliary-air, reduced air volume and high performance fume hoods all fall under the by-pass chemical fume hood umbrella.

Of these hoods, high performance hoods operating on a variable air volume (VAV) system are the most energy efficient. Hoods exist for special circumstances as well. Such as those particularly suited to handle perchloric acid, constructed of acid resistant materials. Also for radioactive applications, hoods constructed with extra decontamination features that often require filters in ductwork.

Biosafety Cabinets: Variations

Class I BSCs have an open front, operate under negative pressure and only provide user protection. The most common types of BSCs, Class II, fall under





three main divisions: Type A, B and C. Class II, Type A BSCs recirculate air back into the lab. Unless however, they are canopy connected to the outside as required by the application (work with odorous materials). Class II, Type A1 and A2 BSCs are similar, yet separated by the minimum average inward air velocity required. Type A BSCs cannot handle work involving radionuclides or hazardous chemistry.

Class II, Type B BSCs are hard ducted to dedicated exhaust systems. They are suitable for work with hazardous chemistry (per a risk assessment), if required by the microbiological studies being performed in the interior of the BSC. Type B1 BSCs recirculate a percentage of air back into the lab while B2 BSCs are entirely exhausted.

Class II, Type C BSCs are hybrids of a sort. They're reminiscent of Type B1 BSCs. The Type C1 is suitable

for work with or without hazardous chemistry, utilizing installation flexibility to be ducted or not. It relies on single pass airflow through a defined area of the work zone and recirculation in outlying areas of the BSC. This reduces energy demands while providing containment of biological, particle and chemical hazards.

Class III BSCs are completely enclosed and feature attached rubber gloves.

Other types of enclosures. Carefully select the proper enclosure for your intended operation. Using the appropriate equipment helps protect personnel and the lab itself. It can also preserve the integrity of your work. Other relevant lab equipment can include glove boxes, clean benches and balance enclosures. If your application involves nanoparticulates, there are also enclosure options designed to accommodate your specific needs.

Differences between American & European BSCs

National Science Foundation's (NSF) [NSF 49](#) and [EN 12469](#) are both standards by which biosafety cabinets (BSCs) are manufactured, specifically outlining how they perform. American National Standards Institute ([ANSI](#)) recognized NSF 49 in 2002, though the standard has been in use since the 1970s. NSF 49 was also the basis from which the EN 12469 standard was derived. NSF 49 standardizes and recognizes the different subcategories of Class II BSCs (A1, A2, B1, B2, C1), and EN 12469 defines a “general Class II cabinet.” EN BSCs are nearly equivalent to NSF Class II Type A2 BSCs. The differences between the NSF and EN standards are explored in this article.

Microbiological challenge testing. NSF 49 allows for testing and acceptance via a microbiological challenge. EN 12469 allows for testing and acceptance via either a microbiological challenge or a KI discus method test.

Downflow velocity. EN 12469 places a requirement on downflow, NSF doesn't. However, NSF requires a larger test sample size and requires traceable test equipment for more verifiable testing results. The broad range of BSC ‘Types’ listed in NSF results in a broader range of downflows, as a result of multiple mechanical designs. Regardless of downflow velocity, both NSF listed and EN certified BSCs must pass similar protection tests.



Microbiological challenge testing on an NSF listed Class II, Type A2

Inflow velocity. NSF is very specific about inflow requirements. Using a direct inflow measurement (DIM) as the primary standard provides repeatable and accurate inflow measurements. EN performs inflow tests by measuring the airflow above the exhaust HEPA filter and back calculating the inflow. NSF A2 requires 0.5 m/s, EN requires 0.4 m/s.

Performance envelope. Defined as the air speed parameters for which the BSC must operate, NSF requires that the Class II BSC must function +/-0.025 m/s of the inflow and downflow set points. EN does not have a matching specification, but Class II BSCs must again meet protection testing requirements.

Pressurization testing. NSF requires that every unit manufactured undergo a “soap bubble pressure leak test” to verify the BSC is of airtight construction. EN requires a “type-test” performed by an independent lab to ensure a design’s leak prevention.

Construction. NSF emphasizes cleanability of contaminated surfaces. EN specifies that Class II BSCs should be resistant to disinfectants and fumigation.

Decontamination. EN BSCs frequently include gas-tight sash and exhaust cover seals with connection ports for the administration of decontamination fumigants such as formaldehyde, vaporous hydrogen peroxide, or chlorine dioxide by operators. NSF requires that BSCs be designed so that they can be decontaminated in situ by trained certifiers.

Regardless of the differences between the NSF 49 and EN 12469 standards, the BSC is only as safe as the individual operating it. Operation, maintenance and certification protocols/schedules should be adhered to as prescribed by the BSC manufacturer and the user's safety officer.



Gas-tight seal in 'open' position on an EN certified Class II, Type A2



Gas-tight seal in 'sealed' position on an EN certified Class II, Type A2

BSC selection guide

There are multiple biosafety cabinet (BSC) classes. But what are they and how are they different? BSC classes are categories describing how the BSC works and what it protects. These “categories” are Class I, Class II and Class III.

Class I. A **Class I** is defined as a ventilated BSC for personnel and environmental protection. Class I BSCs

do not offer product protection from contamination, significantly limiting their applications. They use unrecirculated airflow away from the operator. Class I BSCs have a similar airflow pattern to a fume hood but they also have a HEPA filter at the exhaust outlet. They may or may not be ducted outside. Class I BSCs are safe for use with agents requiring Biosafety Level (BSL) 1, 2 or 3 containment.

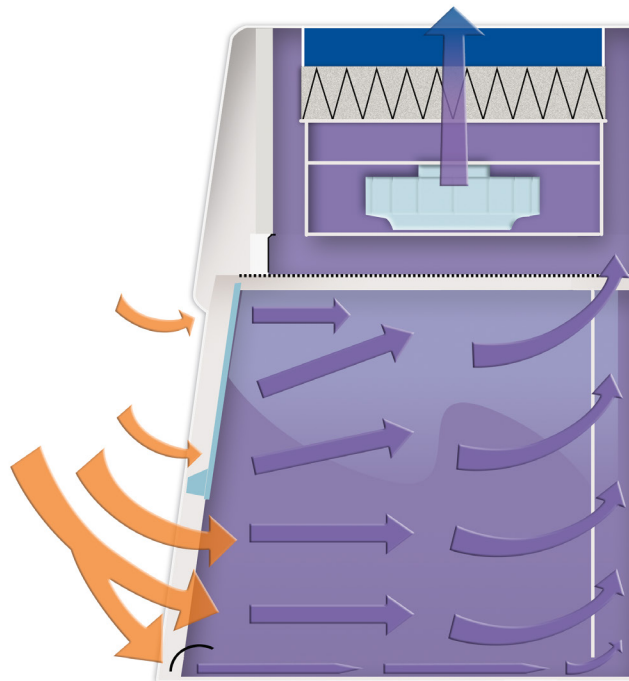

Class II

Room air HEPA-filtered air Unfiltered air under negative pressure

Class II. A **Class II** is defined as a ventilated BSC for personnel, product and environmental protection for microbiological work or sterile pharmacy compounding. Class II BSCs are designed with an open front with inward airflow (personnel protection), downward HEPA-filtered laminar airflow (product protection) and HEPA-filtered exhaust air (environmental protection). These BSCs are further differentiated by types based on construction, airflow and exhaust systems. The types include A1, A2, B1, B2 and C1. They require all biologically contaminated ducts and plenums to be under negative pressure or surrounded by negative pressure ducts and plenums. Type B2 BSCs take this a step further, requiring all biologically contaminated ducts and plenums to be under negative pressure or surrounded by directly exhausted negative pressure ducts and plenums. Like Class I BSCs, Class II BSCs are safe for work using agents requiring BSL 1, 2 or 3 containment.

Type A1. A Class II, Type A1 BSC must maintain a minimum average inflow velocity of 75 fpm through the sash opening. They may exhaust HEPA-filtered air back into the lab, or may be exhaust outside using a canopy connection. They are suitable for work using biological agents without volatile toxic chemicals and volatile radionuclides, but not for sterile hazardous pharmacy compounding.

Type A2. A **Class II, A2** must maintain a minimum average inflow velocity of 100 fpm through the sash opening. Like Type A1 BSCs, they may exhaust HEPA-filtered air back into the lab, or may be exhausted outside using a canopy connection. Type A2 BSCs with a canopy connection are safe for work involving biological agents treated with minute quantities of hazardous chemicals. They may also be used with tracer quantities of radionuclides that won't interfere with the work if recirculated in the downflow air.

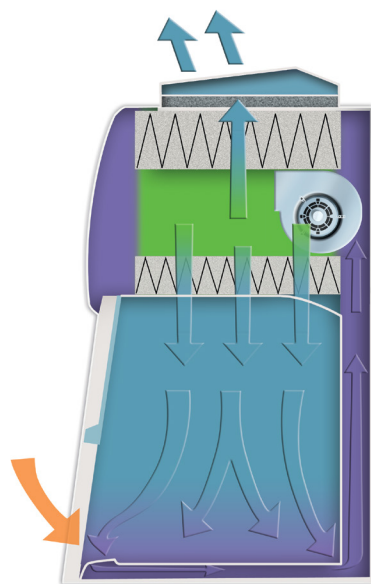

Class II, Type A1

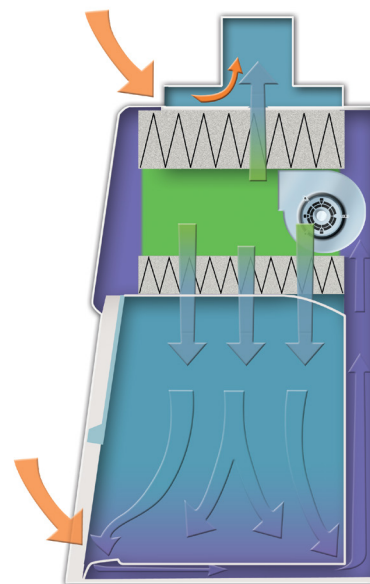

Class II, Type A2

■ Room air
 ■ HEPA-filtered air
 ■ Unfiltered air under negative pressure
 ■ Unfiltered air under positive pressure

Type B1. A Class II, Type B1 must maintain a minimum average inflow velocity of 100 fpm through the sash opening. They have HEPA-filtered downflow air composed mostly of uncontaminated recirculated inflow air and exhaust most of the contaminated downflow air through a dedicated duct is directed outside after passing through a HEPA filter. Similar to Type A2 BSCs, Type B1 BSCs are safe for work involving agents treated with minute quantities of toxic chemicals and tracer amounts of radionuclides if the chemicals or radionuclides won't interfere with the work if recirculated in the downflow air. Unlike a Type A2, a Type B1 BSC is also suitable for work involving minute quantities of toxic chemicals and tracer amounts of radionuclides required as an adjunct to microbiology applications as long as the work is done in the directly exhausted rear

portion of the BSC (this portion is not marked and therefore ever-changing as the airflow pattern adjusts with the loading of the BSC's HEPA filters).

Type B2. A Class II, B2 must maintain a minimum average inflow velocity of 100 fpm through the sash opening. They have HEPA-filtered downflow air drawn from the lab or the outside air (not recirculated from the BSC exhaust) and exhaust all inflow and downflow air to the atmosphere after filtration through a HEPA filter without recirculation in the BSC or return to the lab. Because of this, they are sometimes referred to as 100% exhaust or total exhaust BSCs. Type B2 BSCs are suitable for work involving biological agents treated with hazardous chemicals and radionuclides required as an adjunct to microbiology applications.

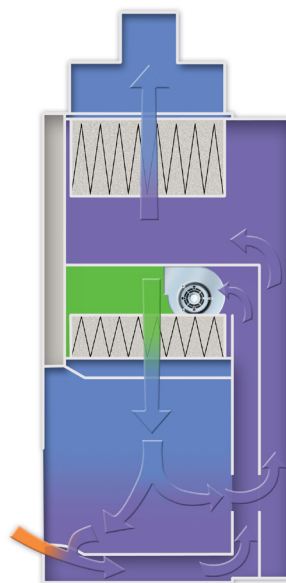

Class II, Type B1

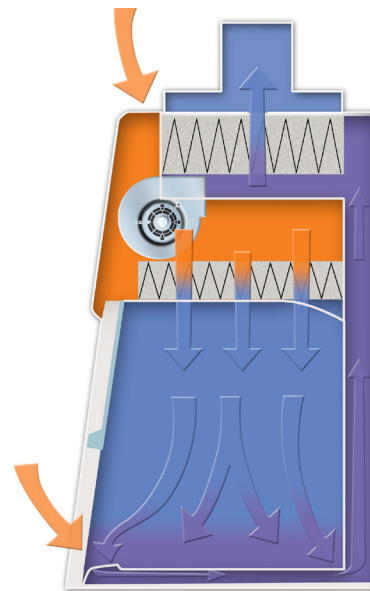

Class II, Type B2



Type C1. A **Class II, C1** must maintain a minimum average inflow velocity of 105 fpm through the sash opening. Type C1 BSCs are unique in that they can operate as either a Type A BSC when in recirculating mode or a Type B BSC when exhausting. C1 BSCs can be quickly changed from one mode to the other by connecting or disconnecting the exhaust and having the cabinet recertified. The Type C1 also features a work surface with clearly delineated spaces for storage on the sides and work use in the center. The center work area, when in Type B-mode, has dedicated direct exhaust so is appropriate for use with hazardous vapors or radionuclides.

Class III. A Class III is defined as a totally enclosed, ventilated cabinet with leak-tight construction and attached rubber gloves for performing operations in the cabinet. Class III BSCs are also called glove boxes. The cabinet has a transfer chamber that allows for sterilizing materials before they leave the glove box. The cabinet is maintained under negative pressure and supply air is drawn in through HEPA filters. The exhaust air is treated with either double HEPA filtration or HEPA filtration and incineration. Class III cabinets are safe for work requiring BSL 1, 2, 3 or 4 containment.

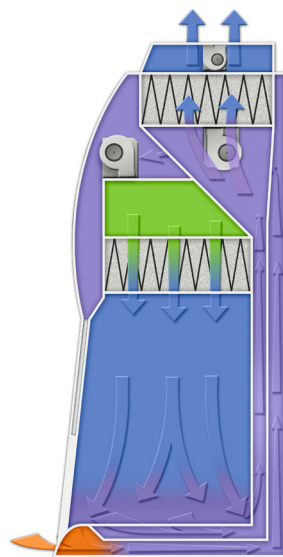

Class II, Type C1

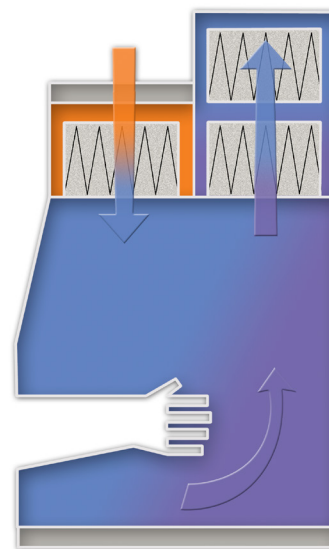

Class III



To B2 or not to B2? That is no longer the question

Regardless of your industry, having the right tools for the job matters. That statement goes both ways, too. Of course you want equipment that allows you to perform effectively and safely. But you don't want to incur any added expenses for features or protections your work doesn't necessarily warrant.

In other words, if you're a carpenter, you're going to need a hammer—a good, dependable hammer. You don't want to reach for the blunt end of a screwdriver in desperation. Or resort to reading an instruction manual for a complicated, expensive gadget you're too frustrated to use.

What if your hammer could do other things you needed it to do, though, and actually save you money in the long term? The product team at Labconco designed a completely new biosafety cabinet (BSC) that can function in either Type A-mode or B-mode. It's swiftly becoming the Swiss Army Knife for lab toolboxes around the U.S. ([like this one at Creighton University](#)).

Before we explore the [Class II, Type C1 BSC](#), let's delve into the backstory. It starts by addressing the longtime struggle of many labs: determining what kind of BSC—a Class II, Type A2 or B2—is actually required.

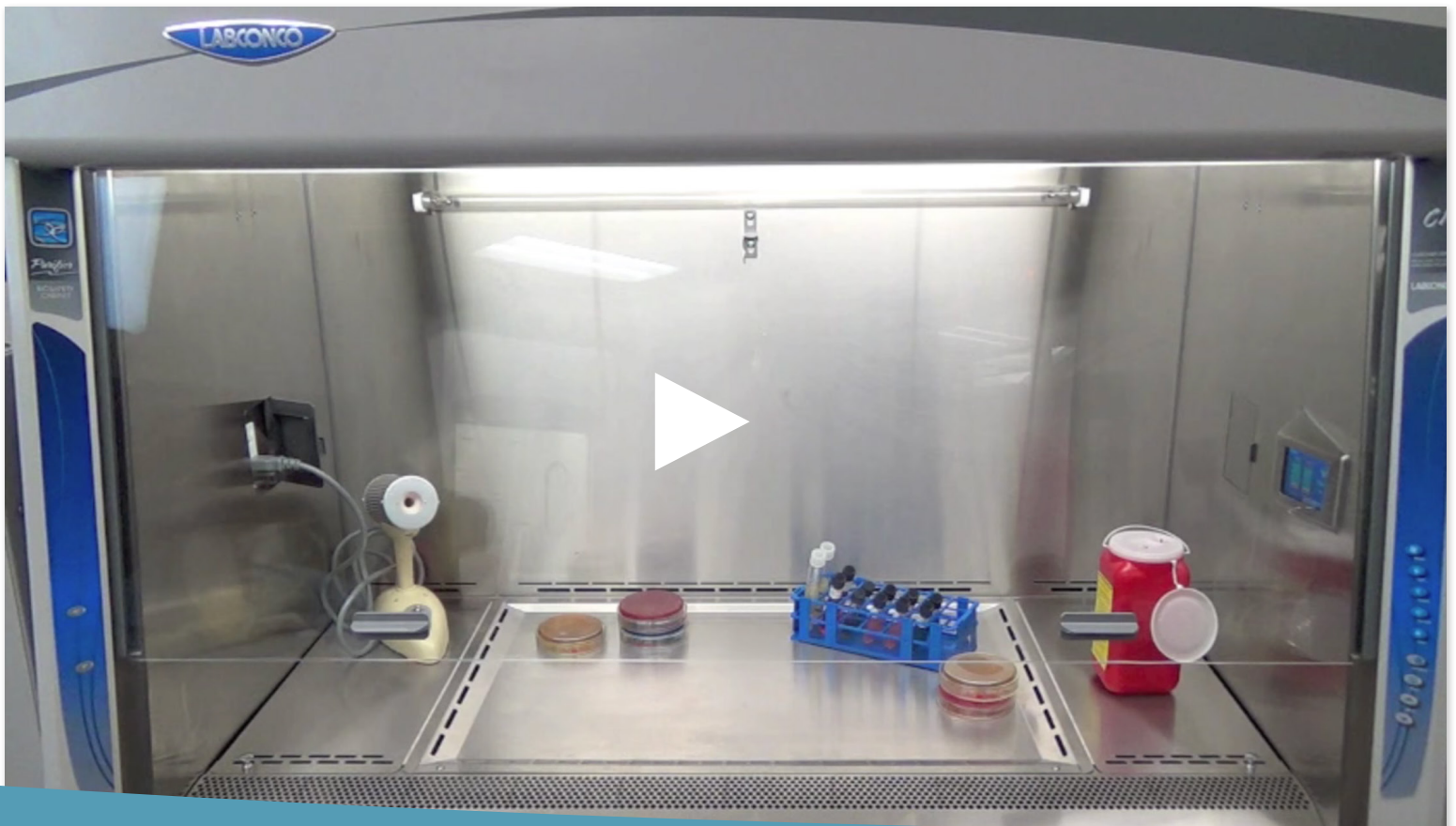

HAZARDOUS CHEMISTRY? It's important to note that although they're often used interchangeably in the industry, 'hazardous chemicals' and 'hazardous chemistry' do not mean the same thing.

For example, if you're working with a hazardous chemical, you don't necessarily need to opt for a Type B2 BSC if that chemical is diluted enough to be rendered non-hazardous.

For many, it's not always clear. That's why a risk assessment must be performed to determine if the volume and concentration of the chemistry you're going to perform is indeed hazardous.

BSC Type Refresher. A2 BSCs recirculate about 70% of air back into the BSC, while exhausting the remaining 30%. This BSC will protect against particulates such as bacteria and viruses. Only small quantities of nuisance chemicals may be used in this BSC when connected to ductwork, since the A2s recirculate (and can concentrate) air within the BSC. Type B2 BSCs exhaust 100% of their air through ductwork. B2s provide the same particulate protection as an A2 and can be used with many hazardous chemicals since all of their air is exhausted, similar to a fume hood.

BSC Choice Struggles. The field of lab research is rooted in change and new discoveries. One thing however, remains unchanged: safety matters.



Typical Class II BSC Exhaust System

Zero Pressure Weathercap

Remote Blower

Canopy Connection

(Type A2 only) or

Sealed Connection

(Type B2 only)

Air-Tight Damper

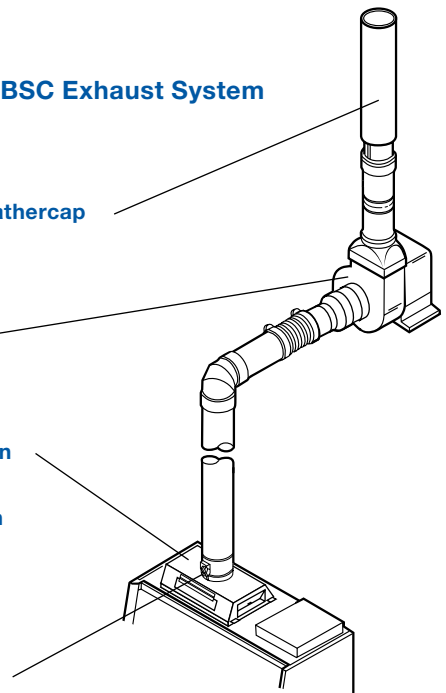

It matters so much that many customers have the same misconception. They want to buy a Class II, Type B2 because they think they are safer than their Class II, Type A2 counterparts.

This is only partly true, and it comes with a hefty application caveat. Type B2 BSCs aren't only safer when your microbiological work uses volatile toxic chemicals—they are required.

In other words, if your application includes hazardous chemistry, you must have a hard-ducted Type B2 (or C1, which we'll get to in a moment).

Some risk assessments find that the application in question warrants a Type A2 BSC. A unit that exhausts about 30-45% of its total airflow while recirculating

the remaining 55-70% within the BSC. In contrast, airflow through a B2 BSC is similar to that of a fume hood, externally exhausting 100% of the air pulled through the BSC. The purpose of this design is to completely remove any toxic chemical vapors or radioactive compounds that are generated inside the BSC.

B2s bring room air into the BSC through both an opening in the top of the BSC and through the inlet grille. This air flows through an initial HEPA filter and then downward through the work area. All of the contaminated air is then drawn into a negatively pressured plenum and exhausted through a second HEPA filter. A dedicated exhaust system and remote blower draw all of the filtered exhaust air out of the lab.

Type C1 A-Mode

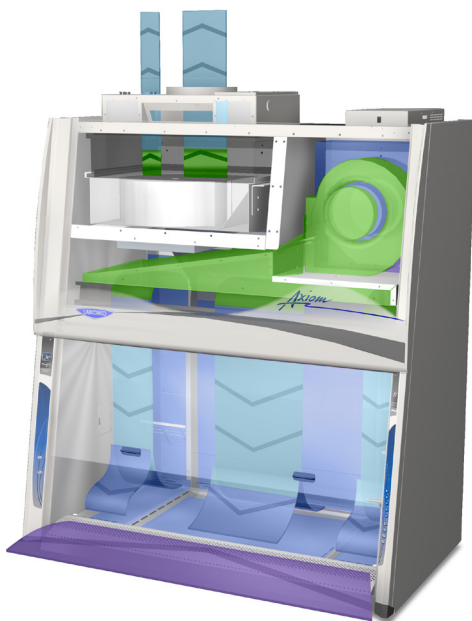

Type C1 B-Mode

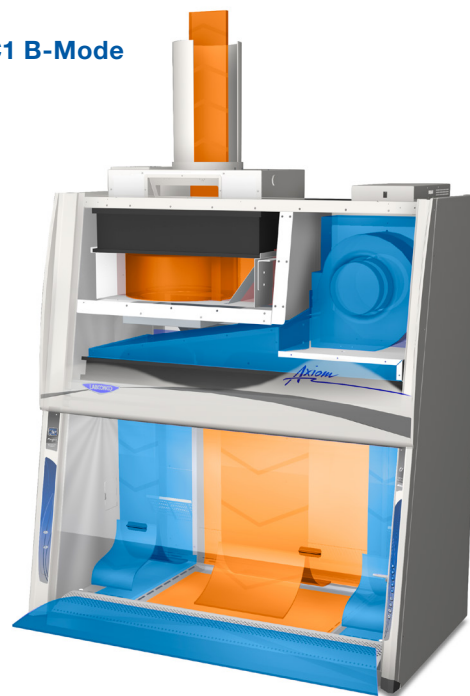

- Room air
- HEPA-filtered air
- Directly exhausted air
- Recirculated air
- Unfiltered air under negative pressure
- Unfiltered air under positive pressure



Regardless of application, Type A2 and B2s can't be converted into different types of BSCs. An A2 is always an A2. A B2 is always a B2. In the past, researchers who needed both Type A and B functionality would have been forced to purchase both types of BSCs.

Type C1: Best of Both Worlds. The Class II, C1 BSC can convert from operation in Type A-mode to B-mode. Running a C1 in B-mode is cost effective, too. It exhausts much less air than a traditional B2. In fact, C1 BSCs exhaust about the same amount of air as an A2 with canopy connection. C1 BSCs can be tied to almost any existing exhaust system with sufficient air volume reserve. As such, C1 installation costs are minimal compared to traditional B2-only uses that require dedicated duct runs and blowers for each BSC.

The C1 utilizes a Chem-Zone™ at the center of the dished work surface, which serves as the dedicated exhaust portion of the BSC when in B-mode. C1 BSCs also have two ECM blowers and consistent inflow and downflow velocities controlled by Constant Airflow Profile™ (CAP) technology. The C1 maintains safety for you and your work, even in the event of a building exhaust failure.

C1 BSCs change the way lab biosafety is approached by combining versatility, flexibility and safety. Labs no longer have to teeter the line between Type A and B or buy multiple units to satisfy multiple needs. The C1 is capable of handling any application. To B2 or not to B2 is no longer the question.

CETA guide on Type B2 BSCs

Class II biosafety cabinets (BSCs) use uniform (laminar) airflow and HEPA filters. They provide protection from particulates (biological) hazards for the user, the product and the environment. Chemical fume hoods use exhaust volume and face velocity to maximize containment and removal of hazardous chemicals and their vapors.

What if you need protection from hazards, both particulate **and** vaporous? Total exhaust, Class II, Type B2 BSCs may have your attention. Ever progressive regulations in the pharmaceutical, healthcare and research industries have increased the interest and the use of “Class II, Type B2” in lab vocabulary.

Characteristics of Type B1 and B2 BSCs

	Type B1	Type B2
Exhaust System	Required	Required
Type	Should have dedicated ductwork and exhaust blower for each BSC	Should have dedicated ductwork and exhaust blower for each BSC
Function	Must pull air through BSC's exhaust HEPA filter and then through ductwork	Must pull air through BSC's exhaust HEPA filter and then through ductwork
Volume	B1 exhausts approximately 20% less than an A	B2 exhausts 100% or more than a Type B1
Negative Static Pressure at BSC	Typically 1.5" H ₂ O minimum Maximum may exceed 4.0" H ₂ O	Typically 1.5" H ₂ O minimum. Maximum may exceed 4.0" H ₂ O
Reserve Capacity	Vacuum requirements may increase up to 2.0" H ₂ O as exhaust HEPA filter loads	Vacuum requirements may increase up to 2.0" H ₂ O as exhaust HEPA filter loads
Other Characteristics		
Cabinet Flexibility	Must be permanently connected to an exhaust system to function properly	Must be permanently connected to an exhaust system to function properly
Cabinet Cost	More expensive than Type A	More expensive than Type A
Installation Cost	Similar to a canopy connected Type A	More expensive than Type A or B1 Higher volumes may require larger ductwork

This amplified focus on Type B2 BSCs called for a central resource to spell out the requirements and guidelines for B2 BSC installation. These guidelines maintain maximum safety for the environment, the product and, most importantly, the users in increasingly hazardous lab scenarios.

The Controlled Environment Testing Association's (CETA) application guide (CETA CAG-007-2010) addresses this need. It is meant to educate lab management, support field certifiers and 'unite' the BSC manufacturing industry. The CETA document illustrates important and often missed information critical to the correct installation and operation of Type B BSCs.

Among subjects visited are:

1. How to choose the right BSC (Type A vs. B)
2. Theory of operation
3. Characteristics of the various BSC types
4. Site requirements: cabinet location and exhaust system parameters, design and construction
5. Dedicated exhaust requirements for Type B BSCs



Type C1, the right compounding BSC

The newest subtype of Class II biosafety cabinet (BSC) is bucking many trends and decades-old canon. The Class II, Type C1 provides multiple benefits to the modern lab.

Here are four reasons why it best suits the needs of the pharmaceutical compounding facility of tomorrow.

Convertibility of BSC operation. Requirements for compounding hazardous, sterile drugs (under USP <797> and <800>) have long held that a total exhaust

or Type B2 BSC is the preferred open-faced enclosure. USP <800> maintains that most compounding processes require only an A2 unless using chemicals that create hazardous vapors.

The Class II, Type C1 is safer than a Type B and is operationally more flexible than an A. A C1 BSC can be ducted in a B-mode. It enhances chemical safety above that of a Type B through use of dedicated exhaust and superior alarm condition programming. See [Active Protection Protocol](#).

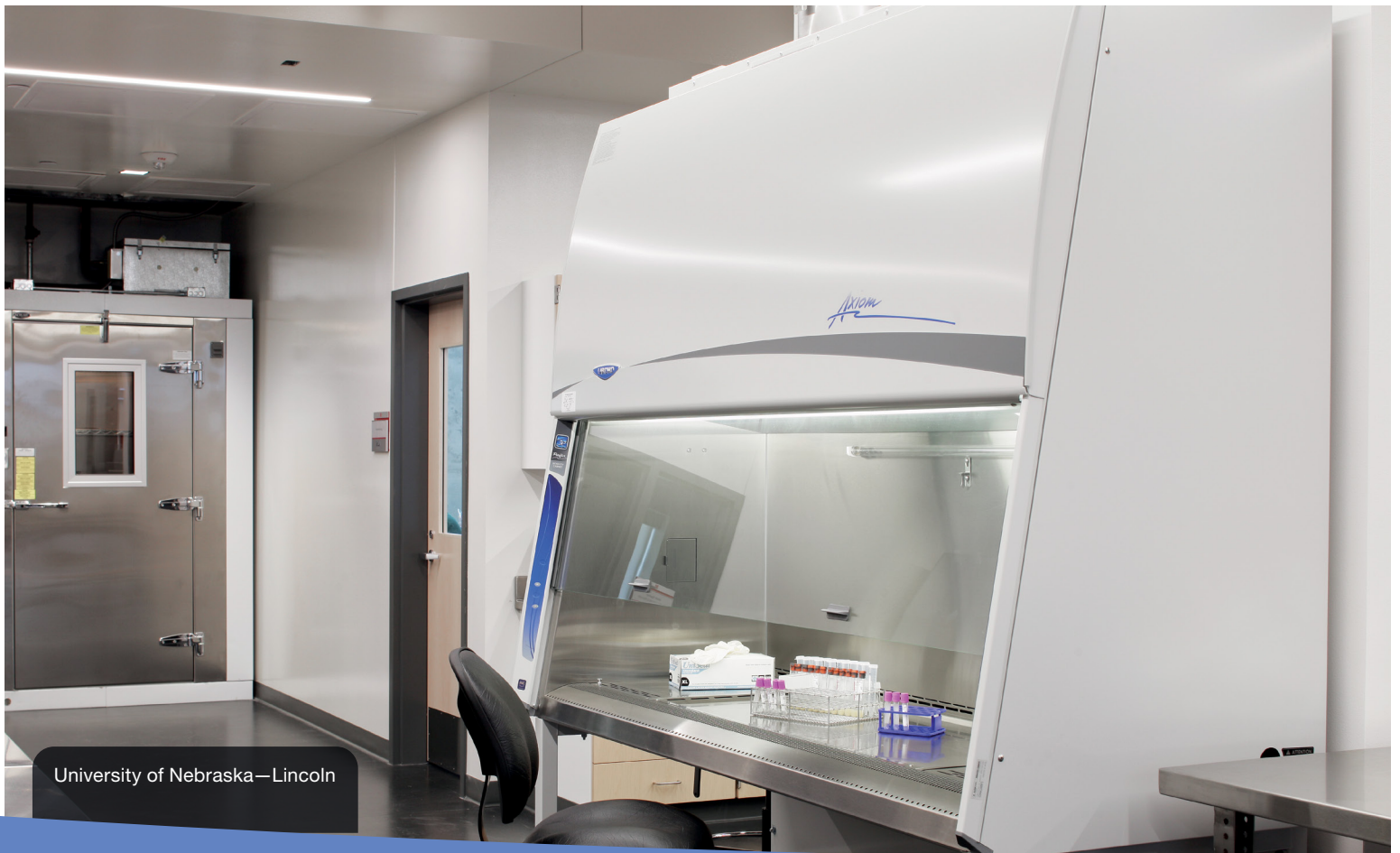

University of Nebraska—Lincoln



Airflow requirements closer to an A. The large volume of air needed to exhaust a B2 BSC is a leading cause of initial lab commissioning failures. Why? Modular cleanrooms are limited in their overall size, and B2 BSCs require more than many air handling systems and rooms can provide.

The following can occur:

1. B2 installation causes the room to be so negatively pressurized that doors become difficult to open
2. There isn't enough air to feed the B2 so it goes into an exhaust alarm state
3. Small rooms with a B2 against one wall become proverbial wind tunnels, creating uncomfortable and unreasonable working conditions

Because a C1 uses airflow channeling, compared to mass airflow evacuation found in a B2, it is more suitable for cleanroom installation. Type C1s use approximately half as much air, making cleanroom air balance and stability far easier to achieve and maintain. Furthermore, since USP <800> requires containment devices to operate 24 hours a day, the cost savings of the C1 is even more pronounced over any B2. Commissioning failures are less likely.

Bag-in/bag-out exhaust HEPA filter. The airflow requirements (and associated cost) of a B2 BSC typically leads to the selection of an A2 BSC with exhaust canopy, and understandably so. However, A2s lack the ability to truly house bag-in/bag-out (BIBO) HEPA filters.

Standard modular cleanroom is 8' tall (96") from floor to top of roof panel. An interior height is closer to 95"

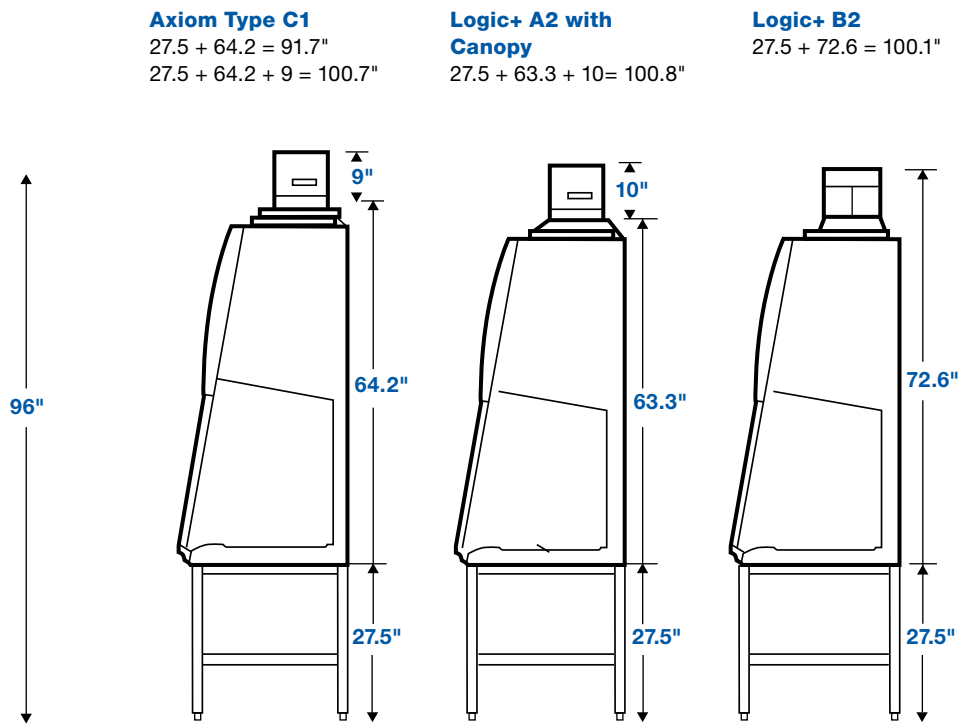

Such filter designs are uniquely required for pharmaceutical compounding and research work. Like B2 BSCs, the C1 can be factory built with BIBO exhaust HEPA filter ensuring that the filter can be changed without contaminating the lab with hazardous particles.

Lower clearance height is an often overlooked problem for modular cleanrooms. Most standard cleanrooms have a total height of 8'. Most B2 BSCs on a base stand, with a working height of 30" (seated height) exceed 8', 4" of total height. As such, specialty panels are needed in the cleanroom's ceiling, thus increasing project cost.

The C1, configured as the B2 just mentioned, has a total height of 7', 8". Other than the penetration required for the duct stub (needed for any Class II BSC going into a USP <800> cleanroom), no further modification is needed.

The Class II, Type C1 BSC addresses a number of significant gaps between A and B BSCs. As highlighted above, several of these advantages significantly benefit the needs and requirements of compounding pharmacies.

For more information on how the C1 addresses gaps in modern design and function, visit BSCno-brainer.com.

Type C1 case study

The Challenge: Boost environmental consciousness in research labs without sacrificing safety.

The innovative culture at Creighton is contagious. Faculty and administrators have a history of taking initiative when it comes to academics and programs. The same approach held true when, in 2015, a committee was created to focus on facility improvements that could boost sustainability.

Creighton was not alone, though. John Baxter, Director of Environmental Health & Safety (EH&S) at Creighton, described a “nationwide push by universities and research institutions to decrease the energy that they

use for labs without compromising health and safety.” So Baxter—who, combined with Chemical and Sustainability Coordinator, Mary Duda, boast over 23 years of experience in their field—decided to approach a supervisor with an idea.

That supervisor, Associate Vice President of Facilities and Project Management Tim P. Norton, championed the project to fellow members on the Energy Savings Committee (ESC). Take a look at the use of B2 biosafety cabinets (BSCs) in the Beirne Research Tower and Criss Health Sciences Center, as the current functionality requirements might be met with less energy taxing equipment.



Creighton University

Wes Walling is the Director of Mechanical, Electrical and Plumbing Operations at the university. He's also a member of the eight-person ESC. Walling said his team was looking for projects that would have a five-year or better return on investment (ROI).

For starters, they rolled out LED lighting upgrades and installed pressure independent control valves for chilled water. One project in particular, though, stood out. Walling called Baxter's suggestion to replace the B2 BSCs with more energy efficient and flexible models "an absolute winner from the start."

The Solution: Replace B2 BSCs with C1s to be used primarily in recirculating A-mode. Type C1 BSCs can operate in A-mode for use in microbiological applications. They can also be exhausted for B-mode applications like those that involve hazardous vapors or radionuclides.

The existing B2 BSCs at Creighton were original to the facility. Also, as Walling explained, were used because "in the old days, energy was cheap and they just exhausted everything as another way of thinking it was safer."

Baxter met with the principal investigators to determine if a replacement in technology would even be possible, based on applications. He learned that none of them actually needed the full B2 exhaust capability of their units at this time. However, they couldn't rule it out in the future, either. As a result, running the C1 BSCs in A-mode would not result in any current changes in application. However, if the users did need to work with volatile organic compounds (VOCs), they could convert the units to B2 functionality without replacing them.



Purifier® Axiom® C1 BSC

The team went even further. They wanted to maximize the safety of the space in one of the buildings. So, Creighton installed a valve system that is monitored and controlled not only by the temperature but also the need for air exchanges in the labs. Thereby they ensured there are no hazardous chemicals in the air. The system monitors the lab exhaust air for VOC and CO₂ particles, and it alerts EH&S if a room exceeds its parameters. Besides decreasing the amount of energy used to condition the room air, this system also provides an extra level of safety for students and faculty.

The above is just one example of the emphasis on safety at the university. Norton explained the philosophy further, stating, “as the departmental budget manager, efficient use of Creighton University resources is critically important, but safety is never compromised. This project met both goals and will certainly be a model for additional enhancements going forward.”

The result. Saved energy, maintained safety and increased functionality. Baxter believes sustainability is second only to safety when it comes to areas of importance within lab spaces. As such, he said the 11 C1 BSCs fit well into Creighton’s facility. After all, Walling’s projection far exceeds the five-year ROI benchmark for ESC projects. In fact, his calculations show a project with a 2.6-year ROI and an annual energy savings of \$52,645.

Functionality and safety have increased as well. “The design of the bottom pan of the new BSCs provides a visual reminder to workers about the three ‘zones’ they should be working in,” Baxter said. He was referring to the specially designed work space that encourages users to practice aseptic technique and work from clean to dirty.

The Axiom® C1 is less expensive than a conventional Type B BSC, more adaptable than an A and can do the work of both

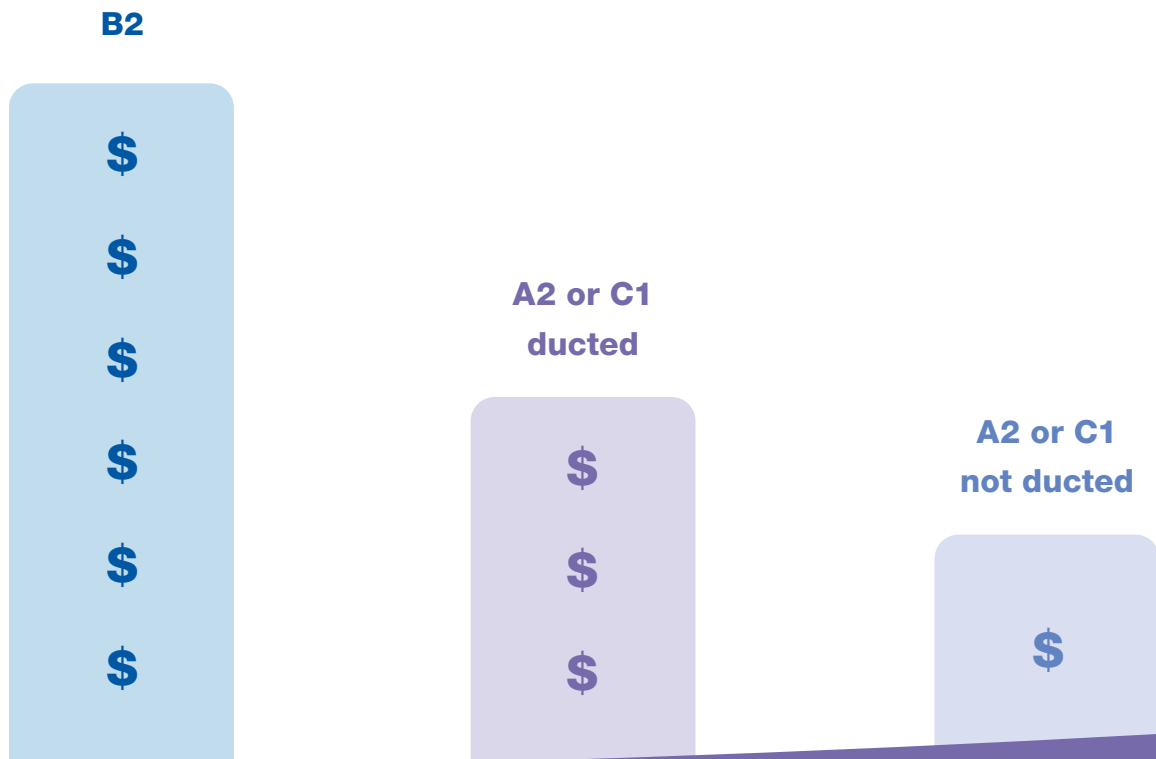

“The design seems to decrease the amount of clutter that is left in the back of the biosafety cabinets. EH&S is happy about that unintended advantage to these cabinets.”

Peter Oldenburg, Assistant Professor in the Department of Pharmacology at Creighton’s School of Medicine, said he found the C1 BSCs quieter than the previously utilized B2s. Noting it is a nice feature for an educational setting in particular. Additional features, especially those that increase safety and ease of use, appeal to Oldenburg and his lab personnel.

“The fact that it automatically goes into sterilization mode for 30 minutes after the sash is closed is terrific, too, as it is one less thing we have to worry about turning off at the end of the day,” Oldenburg said. “Not to mention that it extends the life of the UV bulb.”

From a building perspective, Walling said he couldn’t be happier with the C1 BSCs Creighton purchased to contribute to their ongoing energy saving efforts. “Maybe it was just the right time for technology to finally get in sync with what the lab—and the world—requires for better sustainability.”

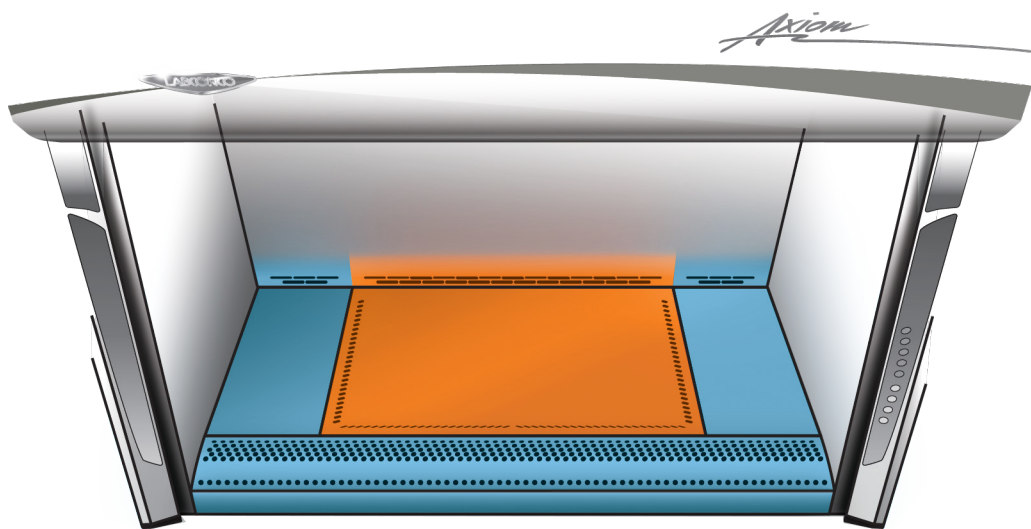

 The Chem-Zone™

 Staging Areas

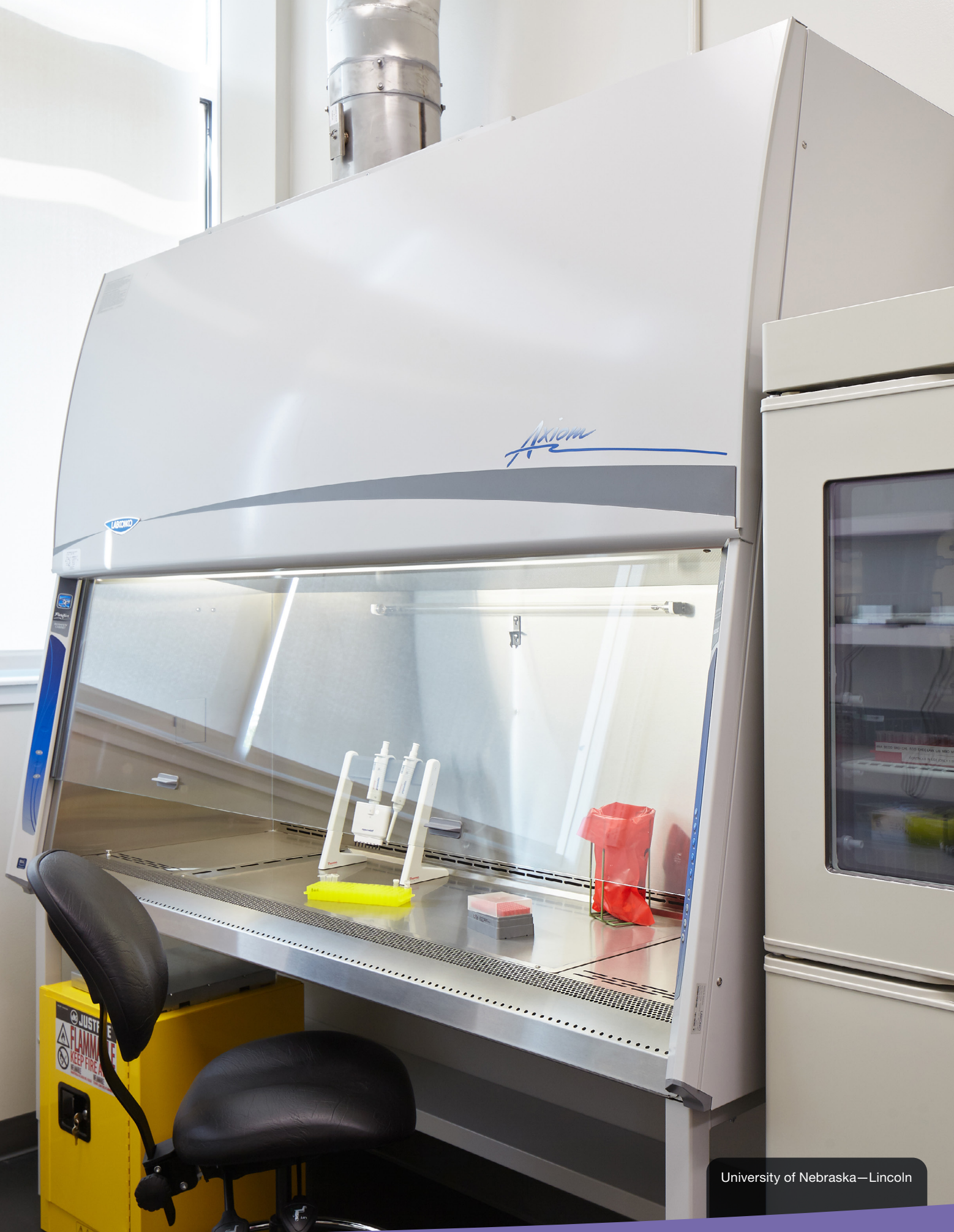

University of Nebraska—Lincoln

4 reasons not to use open flames in BSCs

A **Class II Biosafety Cabinet (BSC)** uses HEPA filtered, laminar (uniform) airflow to provide operator, environmental and sample protection. For the purpose of sterility, HEPA filters are typically rated at 99.99+% efficiency for particles 0.3 micron in size.

Typical microbiological procedures often utilize Bunsen burners or other open flames to sterilize and/or reduce cross contamination. However, the use of such open flames inside of a BSC is not recommended for several reasons.



Charred HEPA filter

- 1.** The Class II BSC **maintains sample protection** through delivery of downward laminar airflow over the work area. Hot air rises, so any open flame causes air to rise against the laminar downflow. This creates turbulence and foils the BSC's ability to protect the samples in the work area.
- 2.** If an open flame gets too hot, it also has the capacity to melt the bonding agent that holds the HEPA filter media to its frame. This destroys the filter's effectiveness, leading to loss of containment in the positively pressured plenum.
- 3.** If the flame goes out and the gas supply valve remains open, flammable gas would be introduced to the BSC unabated. In an **A2**, where up to 70% of the air within the BSC is recirculated, concentrations of the flammable gas could reach explosive potential. This poses a serious risk to not only the BSC, but to the user and the lab it occupies.



BSC with fire damage

4. The Centers for Disease Control and Prevention (CDC) and National Institute of Health (NIH) have also addressed this in the publication: [Biosafety in Microbiological and Biomedical Laboratories, 5th ed., \(BMBL 5th\)](#).

"Several measures can be taken to reduce the chance for cross-contamination of materials when working in a BSC. Opened tubes or bottles should not be held in a vertical position. Investigators working with petri dishes and tissue culture plates should hold the lid above the open sterile surface to minimize direct impaction of downward air. Bottle or tube caps should not be placed on the toweling. Items should be recapped or covered as soon as possible.

Open flames are not required in the near microbe-free environment of a BSC. On an open bench, flaming the neck of a culture vessel will create an upward air current that prevents microorganisms from falling into the tube or flask. An open flame in a BSC, however, creates turbulence that disrupts the pattern of HEPA-filtered air being supplied to the work surface. When deemed absolutely necessary, touch-plate micro burners equipped with a pilot light to provide a flame on demand may be used. Internal cabinet air disturbance and heat buildup will be minimized. The burner must be turned off when work is completed. Small electric "furnaces" are available for decontaminating bacteriological loops and needles and are preferable to an open flame inside the BSC. Disposable or recyclable sterile loops should be used whenever possible."

Best practices if a flame is needed

As outlined by the CDC, if a flame is deemed absolutely necessary, there are types of equipment widely available that are safer alternatives to the Bunsen burner. Some of these use low profile, pedal attenuated flames while others detect motion.

Good. On-demand, low profile, 'safety' burners are available that minimize the impact of a flame on the biosafety cabinet (BSC). Most have control valves that close and pilot lights to burn off extra gas through the valve when not in use. Many have a hands-free option that uses motion detection or foot pedal operation.

Better. While not environmentally friendly, single-use plastic loops and lab supplies are friendlier to BSC use. If a high capacity autoclave is available, consider this a better option to an open flame.

Best. Electrical sterilizers offer the best solution. They can sterilize inoculating loops, needles and culture tubes safely by preventing splashes and aerosols while also eliminating cross contamination. Ceramic tubes dissipate the sterilizing heat, and they do not require gas.



University of Nebraska—Lincoln

UV light use: The good, the bad and the ugly

For decades, germicidal UV lamps have been used in [Class II Biosafety Cabinets](#) (BSCs). The purpose is to keep a BSC's interior clean when not in use. Many researchers swear by the use of their UV lamp and would never consider owning or buying an enclosure without one. Others believe UV lamps provide a false sense of security or don't see the merit of UV irradiation ([such as the NIH](#)). Germicidal lamps utilize UVC radiation (typically between 250-290 nm wavelength). This energy is very good at doing a specific task, but it is a poor broad-spectrum decontaminant, and here is why:

The Good. UVC is a recommended accessory for your [BSC or laminar flow bench](#) when working with cell cultures, PCR or other genetic materials. This is because UVC radiation is efficient at [breaking up the chemical bonds found in DNA and RNA](#). Under prolonged exposure, these chemical changes lead to dysfunctional genetic material and eventual cell death.

The Bad. Germicidal lamps use low energy radiation—so low that the [waves are incapable of penetrating](#) barriers or of reflecting from most surfaces. This means



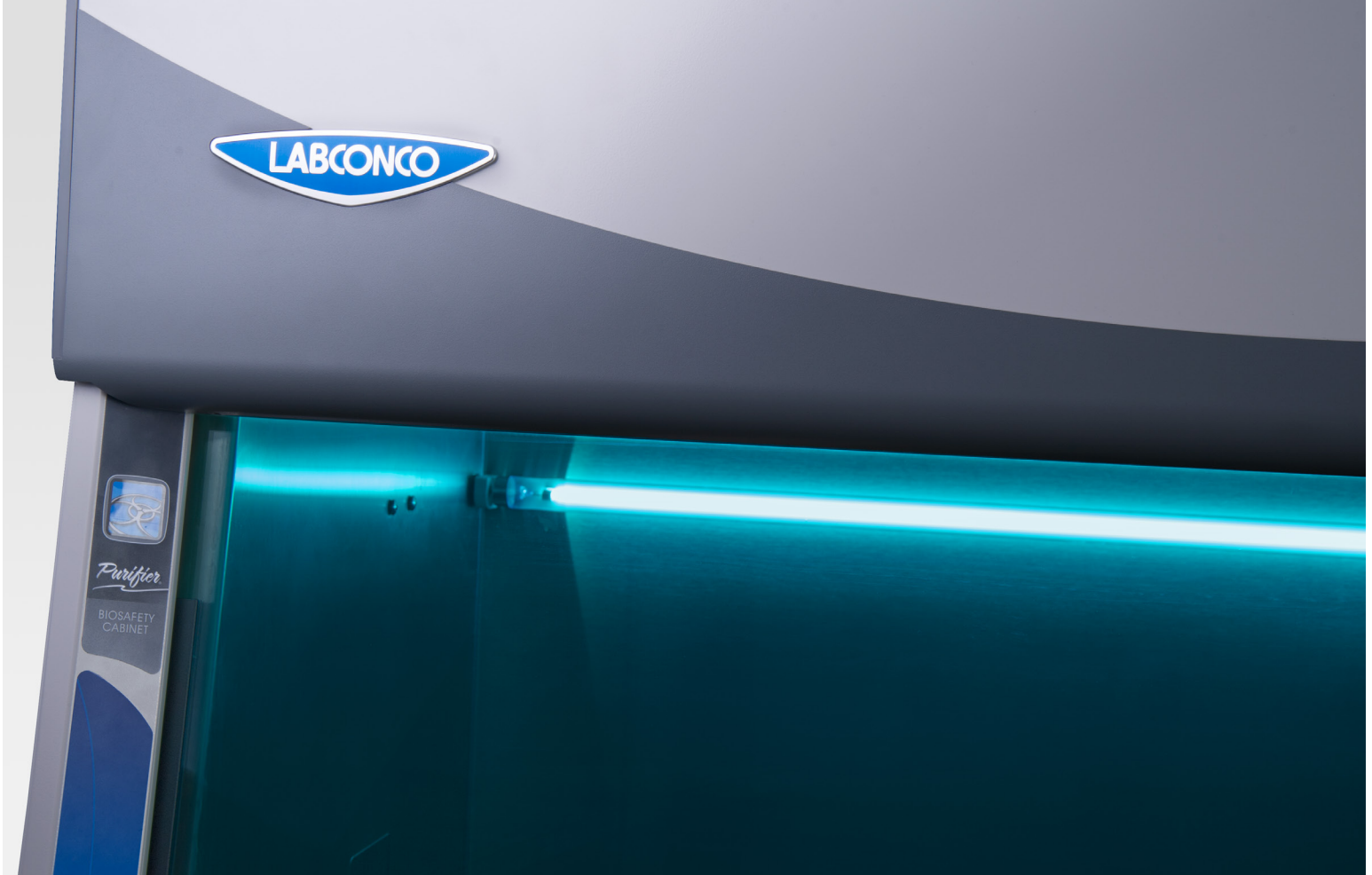

that for UV lamps to be effective, the target **must** be in direct line of sight with the light source. This is bad if you are using a germicidal lamp as the primary decontaminant in your lab's culture enclosure.

However, this is a good thing for those folks in the lab with nothing but a sheet of glass between them and the blue tube of light. That sheet of glass is more than sufficient to block you from getting an unexpected tan.

The Ugly. There is a strong correlation between using a UV lamp for primary decontamination and the frequent presence of cross contamination. True, cross contamination can be caused by a number of factors. However experience shows that labs utilizing UV lamps

as the only means of "cleaning" their BSC, have a higher prevalence of such issues.

Two simple rules for using UV lamps

1. If you are using "naked" DNA/RNA or performing **PCR**, UV lamps are excellent at rendering these materials harmless.
2. If you are doing anything else with biological material, do not rely on UV lamps alone to keep your work area clean. **Always** wipe down exposed surfaces with a proper decontaminant **prior** to turning on the UV lamp. **Always** wipe down exposed surfaces with a proper decontamination **after** turning off the UV lamp.

9 things to know before installing an aspiration system

Following “Best-Practices,” an aspiration system for a cell culture lab would look like this:

- A** primary flask with retaining ring or support to prevent tipping
- B** a secondary flask for overflow protection
- C** filter between secondary flask and vacuum
- D** a vacuum source ([CDC](#))

However, these guidelines are frequently overlooked in improvised system set-ups. Often times, the secondary flask is snubbed. A single flask is placed on the ground without being anchored, nor placed in an overflow bin, and the filter—if included at all—is rarely

replaced or sterilized. When best practices are ignored, a biological risk is posed to the lab, its central vacuum system and those working throughout the facility. Here is what you need to know when investigating an aspiration system for your lab.

Protect the user. First and foremost an aspiration system, improvised or purchased, must be designed to protect the operators and technicians in the lab.

1. Systems should include efficient biological filters, such as 0.2µm, placed between the receiving flask or bottle and the pump vacuum system
2. Receiving bottles should be capable of being autoclaved or sterilized

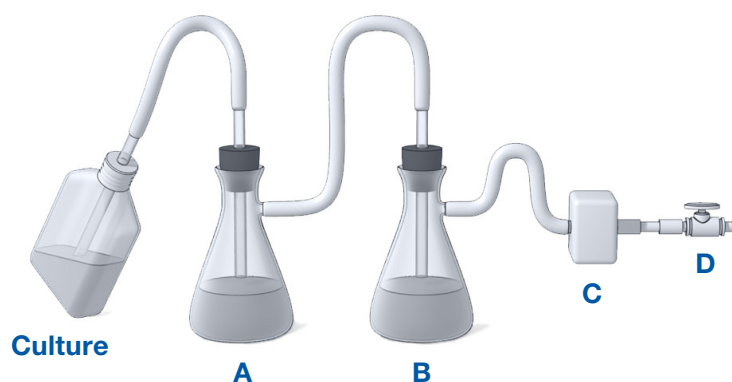

Protect the culture. Maintenance of sensitive cultures is difficult, and cleanliness in the work zone is paramount in the successful management of culture lines.

3. All surfaces of the system should be smooth and easy to clean
4. Tubing should be cleanable or replaceable
5. If the system will be used by multiple users, then tubing lines should be isolated all the way to the receiving flask
6. The receiving flask/bottle should be provided with an appropriate base for support

Protect the lab. Often times, researchers and technicians have a hyper awareness of their immediate surroundings. Though important, they must not neglect the larger lab environment.

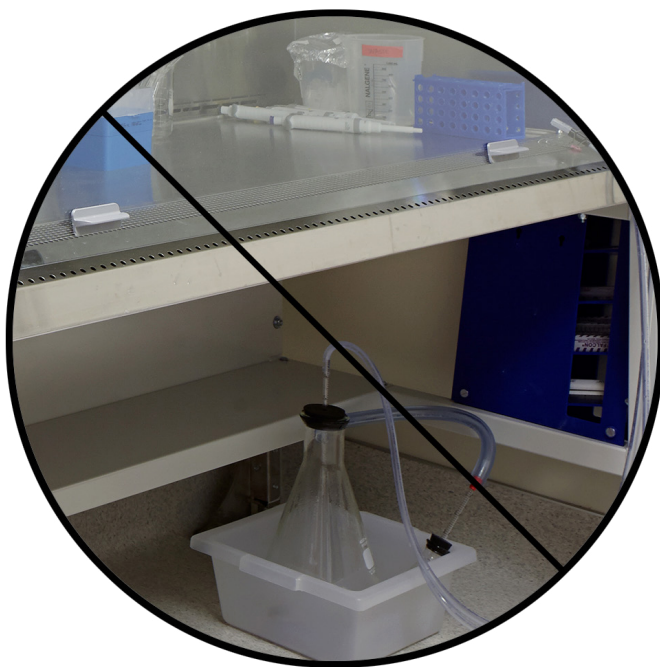

7. A primary disinfectant should be used in conjunction with the receiving flask/bottle. If using bleach as the primary disinfectant in the receiving bottle, ensure that glass is used instead of plastic containers

Maintain control. Whether analog, electromechanical or digital, be sure that the level of vacuum you are using matches your needs.

8. When working with sensitive cells or loose pellets, a gentle vacuum should be applied when removing fluids
9. Large vacuums may be required when removing larger volumes or for higher flow applications



BCV Fluid Vacuum Aspiration Systems

Visit labconco.com/bscebook to learn more.

©2021 LABCONCO CORPORATION
05/17/2021

