

ADAM MC2

A NEW Standard of Automated Cell Counter

Instruction Manual



All the materials in this user manual are protected by Korean and international copyright laws. They cannot be reproduced, translated, published or distributed without the permission of the copyright owner.

ADAM-MC2 Instruction Manual

Website : www.nanoentek.com

E-mail : sales@nanoentek.com

Manufactured by

NanoEntek, Inc.

851-14, Seohae-ro, Paltan-myeon, Hwaseong-si, Gyeonggi-do, 18531, Korea

Tel. +82-2-6220-7940

Fax. +82-2-6220-7999

The information in this manual is described as accurately as possible.

Firmware and software changes and updates may change without prior consent or notification.

Copyright © 2018 by NanoEntek Inc.

All rights reserved. Published in Korea.

Documentation: **NESMU-AMC2-001E**

Revision history: V.0.0 DEC 2018

V.0.3 JAN 2021

Table of contents

Introduction

General description	2
Technology	3
Basic principle of counting	4

Product Contents

ADAM-MC2	5
AccuChip kit	5
Upon receiving the instrument	5

Product Description

Front view of ADAM-MC2	6
Rear view of ADAM-MC2	7

Getting Started

Environmental requirements	8
Power on and initial display	8
Error messages during booting	9
Count setting	10

General Operation

Introduction	11
Sample preparation	12
Counting cell	12

Measure

Run sample	15
Result analysis	16
Result analysis -Error code	17

Data

Data list	18
Edit	19
Image	20
Mail	21

Setting

Setting	22
Wifi	23
Update	23

Power off

Lock	24
Power off	24

Maintenance and cleaning	25
Trouble shooting	26
Warranty	27
Technical specifications	28
Product list	29
Safety precautions	30
Safety symbols	31
Warnings	32
Technical Support	33

General Description

The ADAM-MC2 is a benchtop automated cell counter that performs cell counting and viability measurements using AccuStain Solution.



Technology

Until now, cell counting and viability measurement for many types of cells have been performed manually using hemocytometer with Trypan Blue exclusion method, which is to distinguish viable cells from non-viable cells.

One drawback of this method, however, is the propensity for the staining of artifacts; another drawback is that the naked eye can only differentiate between cells in a limited concentration range in the hemocytometer chamber. This combined with the potential problem of cell aggregation and limited sample volume leads to the common variation of counts normally associated with this method.

To address these problems, NanoEntek has developed the ADAM-MC2, which is based on a fluorescent microscopy technique for counting cells. The ADAM-MC2 utilizes sensitive fluorescence dye staining, LED optics and CMOS detection technologies to make the cell analysis more accurate and reliable.

To count cells using ADAM-MC2, the cells are mixed with a Propidium Iodide (PI) stain or Acridine Orange (AO) stain and directly pipetted onto a disposable plastic chip. The chip is then loaded onto a precision stage. An ADAM-MC2 system automatically focuses on the chip and cells that have been stained are recorded by a sensitive CMOS camera. The image results are automatically processed generating the cell count which is displayed on the front of the instrument. Simple. Fast. Accurate. Reliable.

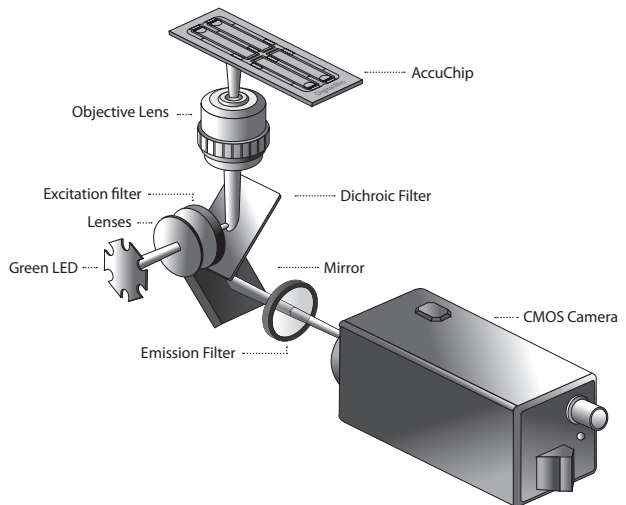

Basic principle of counting

ADAM-MC2 is an instrument which counts mammalian cell DNA by staining with a fluorescent dye, Propidium Iodide (PI) or Acridine Orange (AO). PI does not enter cells with intact membranes or active metabolism. In contrast, cells with damaged membranes or cells with inactive metabolism are unable to prevent PI entering the cell. As a result, the nuclei of cell membrane-damaged normal cells or non-viable cells will be stained. Solution T_{PI} is composed of the PI and cell membrane lysis buffer. Since lysis buffer in Solution T_{PI} changes intact cell membrane to damaged cell membrane condition, both viable cells and non-viable cells can be stained. AO included in Solution T_{AO} is permeable dye which permeates cell membrane and stains DNA. Regardless of the condition of the cell membrane or active metabolism, AO can stain both viable cells and non-viable cells.

The ADAM-MC2 provides two kinds of staining solutions: AccuStain Solution T for the total cell counting and AccuStain Solution N for the non-viable cell counting. AccuStain Solution T is categorized into Solution T_{PI} and Solution T_{AO}. AccuStain Solution N for the non-viable cell counting is composed of the PI alone. After staining samples, the prepared cells will be loaded into the chip. The viability will be automatically calculated in the ADAM-MC2 software after each measurement of the total cells and the non-viable cells.

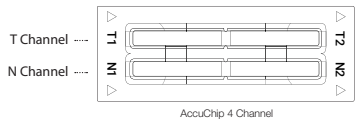
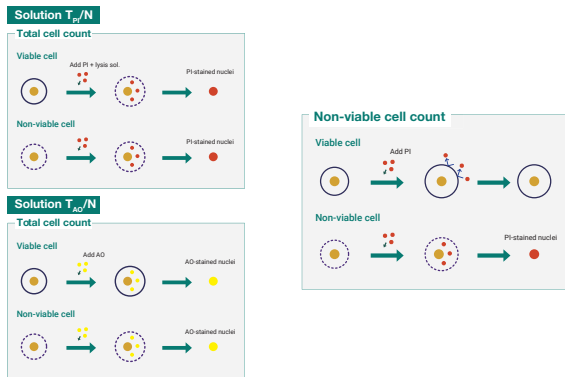

AccuChip 4 Channel



AccuChip 2 Channel

$$^* \text{Viability}(\%) = \frac{(A-B)}{A} \times 100$$

A: Total cell / B: Non-viable cell

ADAM-MC2

The contents of the ADAM-MC2 are listed below:

Item	Quantity
Main device	1
Instruction manual	1
USB hub	1
Wifi dongle	1
Power cord	1
Adapter	1
AccuChip Kit	1
Calibration Bead	1

AccuChip kit

The contents of the ADAM-MC2's AccuChip Kit are listed below:

Item	AccuChip2x Kit (Cat. No: AD2K-200)	AccuChip4x Kit (Cat. No: AD4K-200) (Cat. No: AD4K-200AO)	AccuStain Solution (Cat. No: ADR-1000) (Cat. No: ADR-1000AO)
Disposable Chip	200pcs (2 channel)	200pcs (4 channel)	N/A
Solution T	12.5 mL x 2ea	12.5 mL x 2ea	12.5 mL x 4ea
Solution N	12.5 mL x 1ea	12.5 mL x 1ea	12.5 mL x 2ea
Available test Q'ty	Min. 200 test/kit	Min. 400 test/kit	
	Max. 400 test/kit (Only total cell count)	Max. 800 test/kit (Only total cell count)	

Upon receiving the instrument

- Examine the instrument carefully for any damage incurred during transit.
- Ensure that all parts of the instrument including accessories listed above are included with the product.
- Any damage claims must be filed with the carrier.
- The warranty does not cover in-transit damage.
- Upon receipt, store AccuChip at room temperature. AccuStain Solution should be stored at 2~8°C

Front view of ADAM-MC2

The front view showing various parts of the ADAM-MC2 is shown below:

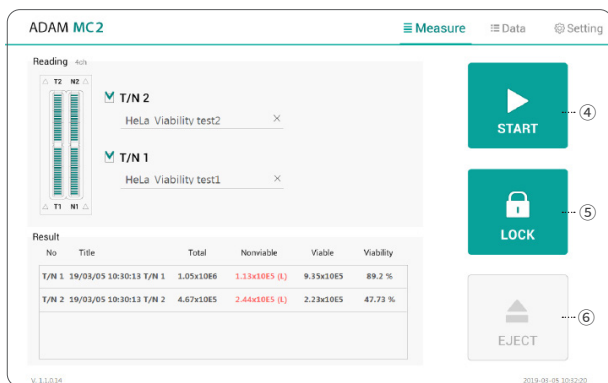

Control buttons	Description
① Door	Slide holder is inserted and ejected.
② Power	Power on / off.
③ LCD	Display processes and results.
④ START	Performs all procedures of automatic counting.
⑤ LOCK	Protects the alignment of stage from external shock when ADAM-MC2 is being moved. Lock ADAM-MC2 before turning it off or moving it.
⑥ EJECT	Ejects the slide holder from ADAM-MC2. Functions as unload.

Rear view of ADAM-MC2

The rear view showing various parts of the ADAM-MC2.

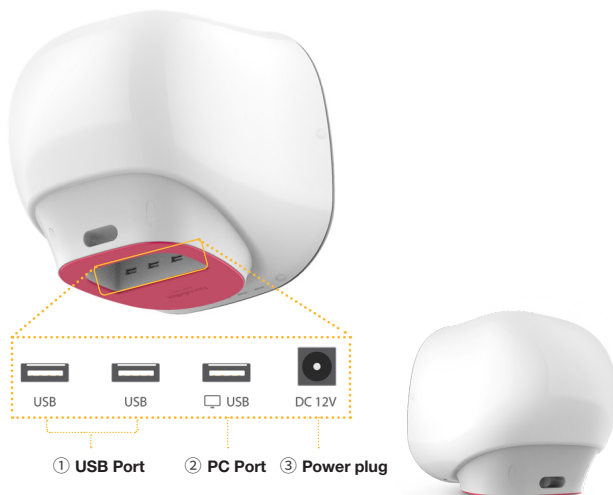

Port	Description
① USB Port	Port for software update and save the data.
③ Power Plug	Connects ADAM-MC2 power cord to wall outlet.

! CAUTION

Do not use the ② PC port. This port does not recognize USB.

Environmental requirements

ⓘ CAUTION

At low temperature ($\leq 10\text{ }^{\circ}\text{C}$), allow the device to warm up for 10 minutes at ambient temperature before use.

To ensure correct operation and stable performance, install the ADAM-MC2 in a location which meets the following conditions:

1. Use at room temperature between 20 and 35 °C
 - Not recommended for cold room use ($\leq 4\text{ }^{\circ}\text{C}$).
2. Do not expose the device to direct sunlight.
3. Do not subject the device to direct or continuous vibration.
4. Do not subject the device to intense magnetic or electromagnetic fields.
5. Do not install the device in high-humidity environment.
6. Location of device should be free from corrosive gases or other corrosive substances.
7. Ensure minimal contact with dust or other airborne particles.
8. Allow a 10 cm (4 inches) minimum space around the device for proper airflow.
9. Do not place any objects on the device.

Power on and Initial Display

1. Check the connection of ADAM-MC2 and power cord.
2. Press the power button for 2–3 seconds.

If you get an error message, please contact your local distributor or sales@nanoentek.com.

If booting is successful and no errors are detected, the home screens will be displayed as below.

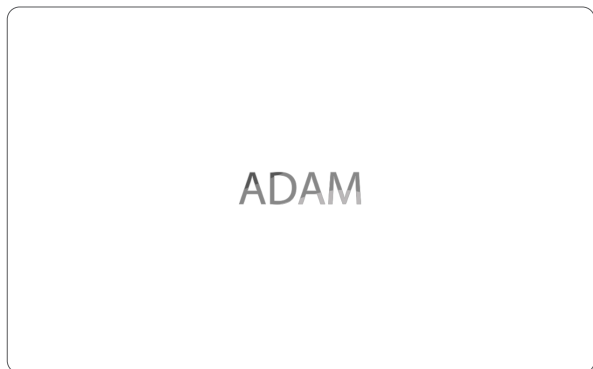

ⓘ CAUTION

- Do not tilt the device too much in the forward when connecting the power cord.
- Do not move the device after connecting power cord.
When you connect the power cord to ADAM-MC2 even without power on the device, it will go through self diagnostic tests.

Error Messages during booting

[System State]

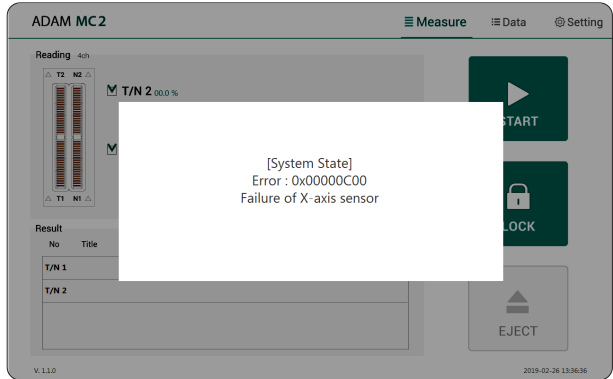

It appears when booting is not working properly.
Turn off main power and restart device.

If this message still appears after restarting,
contact your local distributor or sales@nanoentek.com.

Error code	Cause
0x00000C00	Failure of X-axis sensor
0x00007000	Failure of Y-axis sensor
0x00008000	Failure of Z-axis sensor
0x06000000	Failure of Locking module sensor

Count setting

[AccuChip]

Set the AccuChip according to you are using.

Accuchip

4Ch 2Ch

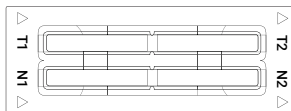

Accuchip

4Ch 2Ch



[Cell size]

Set the minimum and maximum size of cell.

Cell size

Min Max

[Dilution factor]

When diluting sample, set the Dilution factor.

CAUTION

Factor values for the AccuStain Solution is already applied.

Dilution factor

[Solution type]

Set the AccuStain Solution type

T_{Pr}/N T_{AC}/N

Instruction

Instruction is provided in this section for preparing the sample with AccuStain Solution for use with disposable AccuChip for automated cell count using the ADAM-MC2.

Please check the procedure of sample preparation and testing below. For more detailed information, please refer to the next page.

1. Mix the sample with AccuStain Solution.

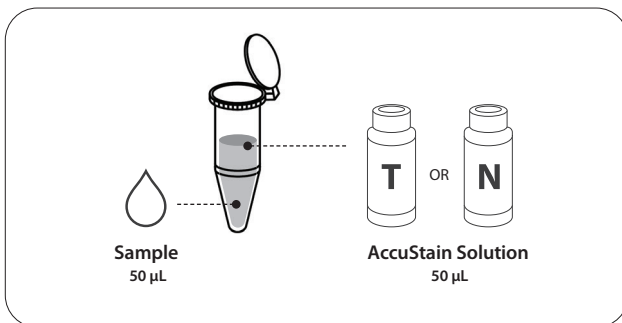

2. Load the mixed sample. Then, wait 1 minute for the sample settling.

- [2 channel: 23 μ L
- [4 channel: 13 μ L
- [T channel: Total cell
- [N channel: Non-viable cell

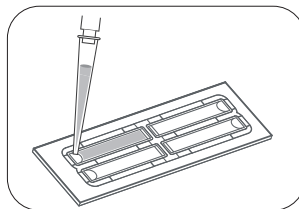

3. Insert AccuChip. Get the result.

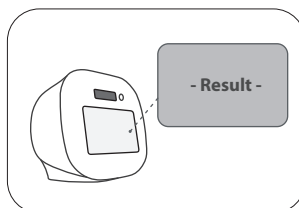
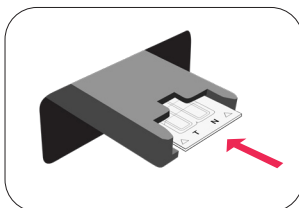

Sample preparation

1. Cultivate the required number of cells.
2. Add an appropriate volume of growth media or PBS to dilute to a final concentration of 5×10^4 cells/mL to 4×10^8 cells/mL (T_{Pr}/N solution).
When using T_{AO}/N solution, prepare to a final concentration of 5×10^4 cells/mL to 2×10^7 cells/mL.

❗ **NOTE** Concentration out of this range will result in errors.
Refer to page 17 for more information about errors.

3. Thoroughly mix the cell pellet by vortexing.
4. Check visually if any cell clumps or agglomerates remain.

Counting cell

[AccuChip 2x]

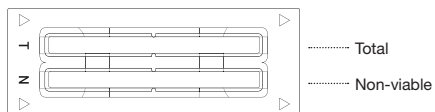

Total Cell	Non-viable Cell
<ol style="list-style-type: none"> 1) Add 50 μL of your sample to 50 μL supplied AccuStain Solution T. 2) Vortex the tube vigorously. 3) Load 23 μL sample mixture to the AccuChip on T channel. Then, wait 1 minute for the sample settling. 	<ol style="list-style-type: none"> 1) Add 50 μL of your sample to 50 μL supplied AccuStain Solution N. 2) Vortex the tube vigorously. 3) Load 23 μL sample mixture to the AccuChip on N channel. Then, wait 1 minute for the sample settling.

[AccuChip 4x]

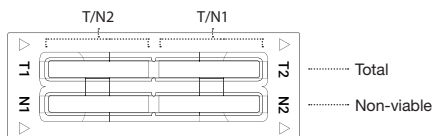

Total Cell	Non-viable Cell
<ol style="list-style-type: none"> 1) Add 50 μL of your sample to 50 μL supplied AccuStain Solution T. 2) Vortex the tube vigorously. 3) Load 13 μL sample mixture to the AccuChip on T1 or T2 channel. Then, wait 1 minute for the sample settling. 	<ol style="list-style-type: none"> 1) Add 50 μL of your sample to 50 μL supplied AccuStain Solution N. 2) Vortex the tube vigorously. 3) Load 13 μL sample mixture to the AccuChip on N1 or N2 channel. Then, wait 1 minute for the sample settling.

❗ **NOTE** When you load of the sample mixture to the AccuChip, please be careful not to make bubbles.

Cell Counting

⚠ WARNING

[Sample loading error]

Be cautious of loading the correct volume of the sample into AccuChip. The instrument will not detect low or high sample volumes.

Correct volume

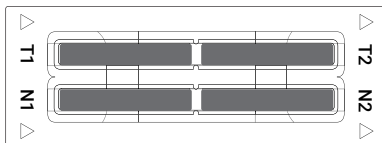

Low volume

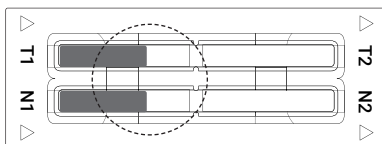

⚠ CAUTION

Avoid bubbles which may negatively affect the result.

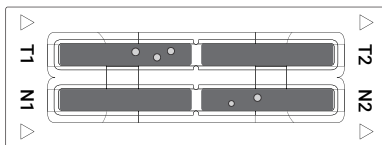

Cell Counting

⚠ WARNING

[AccuChip insert error]

Completely insert AccuChip face up, in the direction of the arrow on the slide. The instrument will not detect if slides are inserted incorrectly. See pictures below for proper insertion.

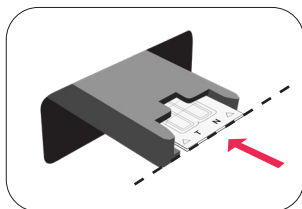

(O)

Correctly inserted

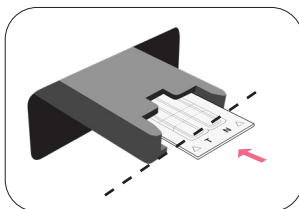

(X)

Not fully inserted

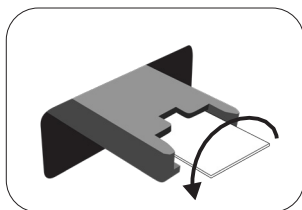

(X)

Upside down inserted

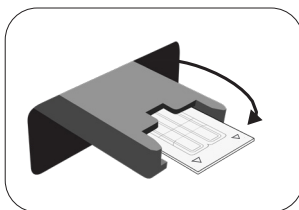

(X)

Wrong end inserted

⚠ CAUTION

- Please insert or remove the AccuChip when the slide holder is fully ejected.
- When the test is finished, please remove the AccuChip from the slide holder.

Run Sample

Start counting process by pressing 'START'.
It may take about 2 minutes longer for auto focus at the initial test.

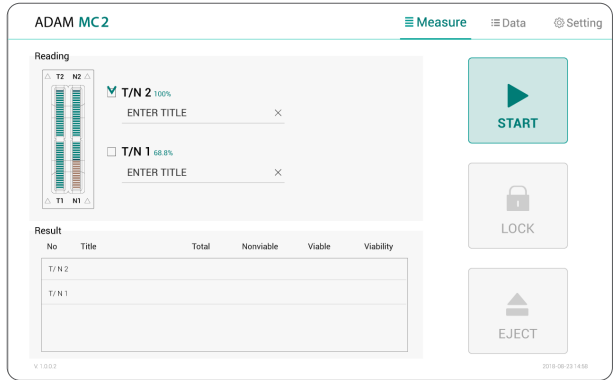

While the test is in progress, you can check the cell images of each channel.



Result Analysis

The result will be displayed after being automatically calculated by ADAM-MC2 software.

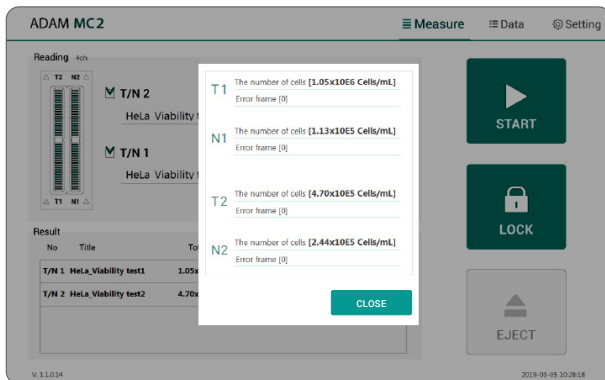

*1.10E6 = 1.10 X 10⁶ cells/mL

Title	Number of Total cell	Number of Non-Viable cell	Viability
HeLa_300µM H2O2	T1 (1.10E6)	N1 (5.50E5)	50%
HeLa_100µM H2O2	T2 (2.20E6)	N2 (5.50E5)	75%

- The viability will be automatically calculated by the ADAM-MC2 software after each measurement of the total cells and the non-viable cells.
- First, the total cell number and second, non-viable cell number are measured and then the cell viability is calculated as subtracting non-viable cell counting numbers from total cell counting.

Result Analysis - Error code

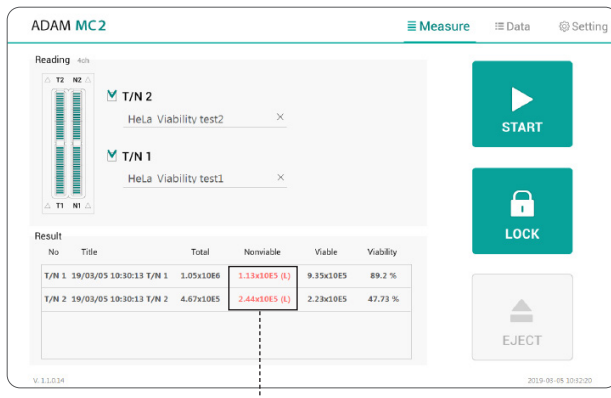

[Solution T_{PI}/N]

Error code	Cause
E	Frames with errors are over 50% of total counting frame.
O	Cells are more than 4×10^6 cells/mL.
H	Cells are more than 2×10^6 cells/mL.
L	Cells are less than 4×10^5 cells/mL.
U	Cells are less than 5×10^4 cells/mL.
Error frame [#]	Frame with error that contains cells whose diameter is larger than $100 \mu\text{m}$. When this error shown in result window, please check the image.

- Please use the solution T_{AC}/N when the cell concentration is above the range of 4×10^6 cells/mL.

[Solution T_{AO}/N]

Error code	Cause
E	Frames with errors are over 50% of total counting frame.
O	Cells are more than 2×10^7 cells/mL.
H	Cells are more than 1×10^7 cells/mL.
L	Cells are less than 4×10^5 cells/mL.
U	Cells are less than 5×10^4 cells/mL.
Error frame [#]	Frame with error that contains cells whose diameter is larger than $100 \mu\text{m}$. When this error shown in result window, please check the image.

Data list

ADAM MC2 Measure Data Setting

Data List

①	All	No	CH	S/M	Sample	Date	Time	Total	Nonviable	Viable	Viability	Start Date
	<input type="checkbox"/>	15	CH2	AD	20-12-18 13:08:11 T-N	2020/12/18	13:08:11	7.19x10E7 (O)	7.16x10E7 (O)	2.83x10E5	0.39 %	2018 / 08 / 23
	<input type="checkbox"/>	14	CH4	AD	20-12-18 13:05:03 T-N	2020/12/18	13:05:03	5.97x10E7 (O)	6.78x10E7 (O)	0.00x10E0	0.0 %	2018 / 08 / 23
	<input type="checkbox"/>	13	CH4	PI	20-12-14 14:07:09 T-N 2	2020/12/14	14:07:09	0.00x10E0 (U)	0.00x10E0 (U)	0.00x10E0	0.0 %	
	<input type="checkbox"/>	12	CH4	PI	20-12-14 14:07:09 T-N 1	2020/12/14	14:07:09	0.00x10E0 (U)	0.00x10E0 (U)	0.00x10E0	0.0 %	
	<input type="checkbox"/>	11	CH4	AD	20-12-10 17:41:21 T-N 2	2020/12/10	17:41:21	0.00x10E0 (U)	0.00x10E0 (U)	0.00x10E0	0.0 %	
	<input type="checkbox"/>	10	CH4	AD	20-12-10 17:41:21 T-N 1	2020/12/10	17:41:21	0.00x10E0 (U)	0.00x10E0 (U)	0.00x10E0	0.0 %	
	<input type="checkbox"/>	9	CH2	AD	20-12-10 17:40:27 T-N	2020/12/10	17:40:27	0.00x10E0 (U)	0.00x10E0 (U)	0.00x10E0	0.0 %	
	<input type="checkbox"/>	8	CH2	PI	20-12-10 17:38:32 T-N	2020/12/10	17:38:32	0.00x10E0 (U)	0.00x10E0 (U)	0.00x10E0	0.0 %	
	<input type="checkbox"/>	7	CH2	AD	20-12-09 16:06:33 T-N	2020/12/09	16:06:33	0.00x10E0 (U)	0.00x10E0 (U)	0.00x10E0	0.0 %	
	<input type="checkbox"/>	6	CH2	PI	20-12-09 16:03:32 T-N	2020/12/09	16:03:32	0.00x10E0 (U)	0.00x10E0 (U)	0.00x10E0	0.0 %	
	<input type="checkbox"/>	5	CH2	PI	20-07-10 11:00:28 T-N	2020/07/10	11:00:28	0.00x10E0 (U)	0.00x10E0 (U)	0.00x10E0	0.0 %	

Start Date: 2018 / 08 / 23
End Date: 2018 / 08 / 23

SEARCH EDIT IMAGE SAVE MAIL DELETE

V.1.3.2 2018-08-23 14:58

Control buttons	Description
① All	Select all data in Data List.
② SEARCH	Display the data of the selected date.
③ EDIT	View and edit the data. Multiple data can be edited with the same settings.
④ IMAGE	Check the cell images of each channel.
⑤ SAVE	Save the selected data to USB(PDF, Excel, Image).
⑥ MAIL	Send the Excel, PDF, and Image files of selected data to e-mail. Delete the selected data.
⑦ DELETE	Delete the selected data.

EDIT



Control buttons	Description
① Sample	Edit the sample name.
② Cell size graph	View the cell size graph each channel(T/N).
③ Cell size setting	Set the min/max size of the cell.
④ Dilution Factor	Set the dilution factor of sample. Factor values for the AccuStain Solution is already applied.
⑤ Frame graph	View the counted cell number each frame.

IMAGE



Control buttons	Description
① Channel	Select a channel.
② Original	Check the original image.
③ Counted	Check the counted cell image.
④ Frame	Select a frame number of the channel.
⑤ Zoom-in/out	Zoom in and out to check the cell image.

MAIL

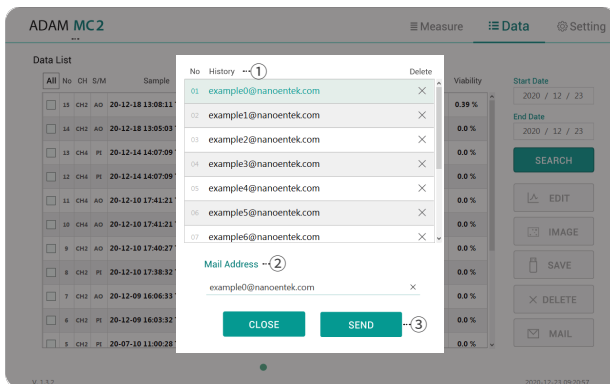

Control buttons	Description
① History	Select an e-mail address from the list to send the Excel, PDF, and Image files of selected data. The e-mail address that received the files remains in the list.
② Mail Address	If you want to receive files by new e-mail, please enter the e-mail address.
③ Send	Send the files to a selected e-mail address. Files can be sent to only one e-mail at a time.

Setting

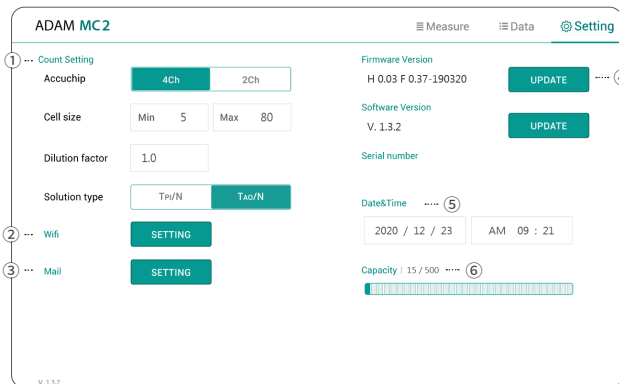

Control buttons	Description
① Count setting	Set the conditions in the setting tap before counting. Refer to page 10 for more information.
② Wifi	Set the wifi to use the e-mail function.
③ Mail	Do not change the setting in mail.
④ Update	Firmware or Software update through the USB.
⑤ Date&Time	Set the current date and time.
⑥ Capacity	Check remaining capacity .

Wifi

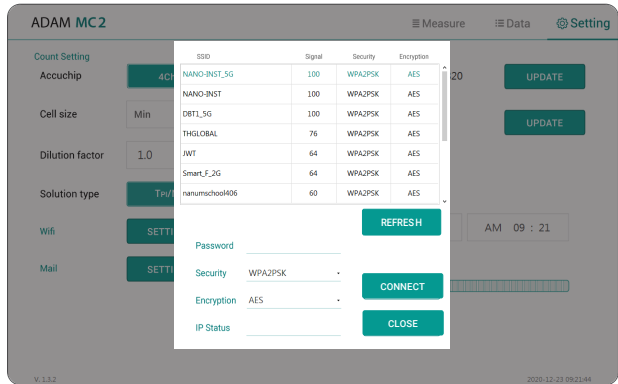

1. Click the Refresh button.
2. Select the wifi.
3. Insert the password of selected wifi.
4. Click the Connect button.

⚠ CAUTION

If connection error occurs, please contact a laboratory facility manager.

Update

1. Prepare the USB with update file.
2. Insert the USB.
3. Click the UPDATE button.

⚠ CAUTION

- The 'AdamUpdate' folder must exist in the root path of the USB folder.
- ADAM-MC2 can be updated only when the firmware or software file exists in the 'AdamUpdate' folder. The 'ADAM MC2.eve' file should be in the 'AdamUpdate' folder.
- Do not rename the 'AdamUpdate' folder. The folder name should be 'AdamUpdate'.

Lock

Press  LOCK before turning off the device.

If there is no operation for 3 minutes, the lock function will be activated automatically.

When the device is locked, the screen will be changed as shown below.

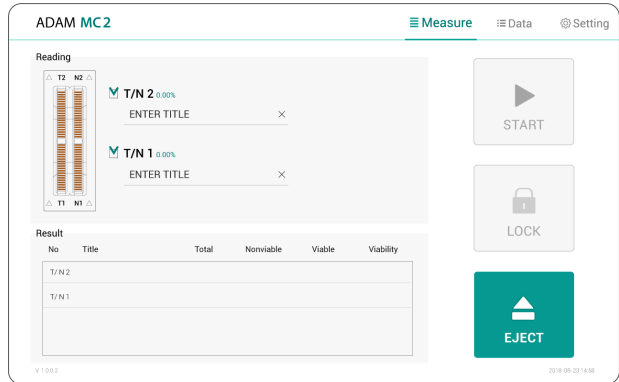

Power off

If you press the power button 2~3 seconds, then 'Slide to shut down your PC' message will appear. Slide down the screen to turn off the power.

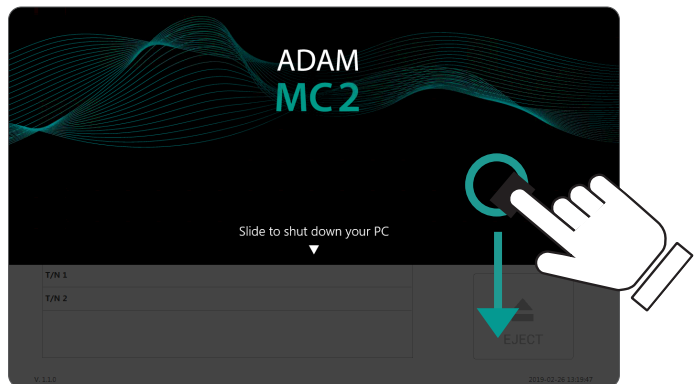

Maintenance and cleaning

1. ADAM-MC2 does not need regular maintenance.
2. ADAM-MC2 has no replacement of consumable materials.
3. Please clean the exposed surface of ADAM-MC2 frequently or before testing, using a soft cloth and isopropyl alcohol or deionized water.

ⓘ CAUTION

Dispose of wipes in an appropriately labeled solvent contaminated waste container.

Trouble shooting

Problem	Description	Solution
ADAM-MC2 does not power up	<ul style="list-style-type: none"> No power from outlet Bad power cord. 	<ul style="list-style-type: none"> Check power source. Replace.
Inaccurate result	<ul style="list-style-type: none"> Cell number may be out of range. AccuStain Solution has expired. Too high clumped cells. 	<ul style="list-style-type: none"> Adjust the number of cells to recommended concentration (refer to page 12). Discard AccuStain that have expired. Purchase the AccuStain (refer to page 29). Try again after vortexing the cells.
When error message is shown (For information on each error message, see page 17)	<ul style="list-style-type: none"> When frames with errors are over 50% of total counting frame. (Error message: E) 	<ul style="list-style-type: none"> Check the suspension of cells if all cells are fully dissociated into single cells. If contaminants except cells are found, prepare sample again.
	<ul style="list-style-type: none"> High concentration of cells (Error message: H) Over detection range (Error message: O) 	<ul style="list-style-type: none"> Check if concentration of cell is too high. Dilute the sample and count again.
	<ul style="list-style-type: none"> Low concentration of cells (Error message: L) Under detection range (Error message: U) 	<ul style="list-style-type: none"> Check if concentration of cell is too low. Use concentrated sample and count again.

Warranty

If any defects occur in the ADAM-MC2 during one(1) year warranty period, NanoEntek will repair or replace the defective parts at its discretion without charge. The following defects, however, are specifically excluded:

1. Defects caused by improper operation.
2. Repair or modification done by anyone other than NanoEntek or an authorized agent.
3. Damage caused by substituting alternative parts.
4. Use of fittings or spare parts supplied by anyone other than NanoEntek.
5. Damage caused by accident or misuse.
6. Damage caused by disaster.
7. Corrosion caused by improper solvent or sample.

For your protection, items being returned must be insured against possible damage or loss. NanoEntek cannot be responsible for damage incurred during shipment of a repair instrument. It is recommend that you save the original packing material in which the instrument was shipped. This warranty should be limited to the replacement of defective products.

For any inquiry or request for repair service,
Contact sales@nanoentek.com or your local distributor.

Technical Specifications

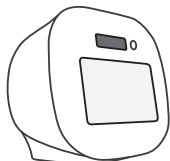

ADAM-MC2	
Measuring range	5x10 ⁴ ~ 4x10 ⁹ cells/mL (PI) 5x10 ⁴ ~ 2x10 ⁷ cells/mL (AO/PI)
Optimal range	4x10 ⁵ ~ 2x10 ⁹ cells/mL (PI) 4x10 ⁵ ~ 1x10 ⁷ cells/mL (AO/PI)
Analysis time	< 25~50 sec/test (For initial test, max. 2 min/test)
Voltage	DC12V
Current	5A
Objective lens	4 X
LED	4W Green LED
Camera	CMOS camera
Filter	Excitation filter, Dichroic filter, Emission filter
Weight	7 kg
Size (W×L×H)	277 × 276 × 270 mm
Degree of protection	IPX0

Operating environment condition

Temperature	0 °C ≤ Temperature ≤ 40 °C
Humidity	10 % ≤ Humidity ≤ 90 %
Altitude	Altitude ≤ 2,000 m

Transportation & storage environment condition

Temperature	-30 °C ≤ Temperature ≤ 60 °C
Humidity	10 % ≤ Humidity ≤ 90 %

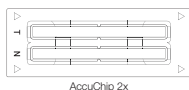

AccuChip 2x



AccuChip 4x



AccuChip Kit

AccuChip

Loading sample vol. per test	23 µL/test (AccuChip 2X) 13 µL/test (AccuChip 4X)
Measuring sample vol. per test	8.6 µL/test (AccuChip 2X) 3.4 µL/test (AccuChip 4X)

Solutions

AccuStain Solution	12.5 mL Total cells (T), Non-viable cells (N)
--------------------	--

Storage temperature

AccuChip	0 – 30 °C
AccuStain Solution	2 – 8 °C

Expiration date

AccuChip	2 year
AccuStain Solution	1 year

Product List

Cat. No.	Product	Contents	Quantity
AD2K-200	AccuChip2X Kit*	200 pcs AccuChip 2X	1
		12.5 mL AccuStain Solution T	2
		12.5 mL AccuStain Solution N	1
AD4K-200	Accuchip 4x Kit (PI)	200 pcs AccuChip 4X	1
		12.5 mL AccuStain Solution T (T _{PI})	2
		12.5 mL AccuStain Solution N	1
AD4K-200AO	Accuchip 4x Kit (AO/PI)	200 pcs AccuChip 4X	1
		12.5 mL AccuStain Solution T (T _{AO})	2
		12.5 mL AccuStain Solution N	1
ADR-1000	Accustain Solution (PI solution)	12.5 mL AccuStain Solution T (T _{PI})	4
		12.5 mL AccuStain Solution N	2
ADR-1000AO	Accuchip 4x Kit (AO/PI solution)	12.5 mL AccuStain Solution T (T _{AO})	4
		12.5 mL AccuStain Solution N	2
ADB-500	ADAM Calibration Bead	5 mL Calibration Bead	1

*AccuChip 2x: please consult your distributor or manufacture for availability.

NOTE

AD4K-200: Total cell is counted by PI with lysis buffer.

ADR-1000: Total cell is counted by PI with lysis buffer.









Safety Precautions

Review and follow the safety instructions below :

- Always ensure that the power supply input voltage matches the voltage available at your location.
- To avoid the danger of electric shock, install the instrument per the environmental specifications located in "Technical Specifications". If water or other material enters the instrument, the adaptor, or power inlet, disconnect the power cord and contact a service person.
- Do not touch the main plug or power cord with wet hands.
- This machine is air-cooled so its surfaces become hot during operation. During installation and use, leave more than 10 cm (4 inches) free around the device.
- Do not install the instrument on a slant or a place prone to vibrations or the risk of instrument malfunction or damage to the instrument will increase.
- Never insert any objects (especially metallic) into the air vents of the instrument as this could result in electrical shock, personal injury, and equipment damage.
- Always set the main switch on the power supply unit to OFF before connecting the power cord to the wall outlet.
- To avoid a potential shock hazard, always connect the grounding terminal of the instrument and that of the wall outlet properly. The power cord should be connected to a grounded, 3-conductor power outlet.
- Position the device so that there is sufficient length for the cables and their respective connections.
- Set the main switch to " O " (OFF), unplug the power cord, and lock the stage before moving.
- If the instrument is broken or dropped, disconnect the power cord and contact an authorized service person. Do not disassemble the instrument.
- Only use authorized accessories.
- Use this equipment only as specified in this manual and as specified in any documentation associated with its components. Use of the equipment in an unspecified manner may result in damage to the device or injury to the user.

Safety Symbols

The following symbols are found on the instrument and this document. Always use the equipment in the safest possible manner.

Symbol	Meaning
	Caution & Warning
	ON (Power)
	This instrument and consumables conforms to the Declaration of Conformity.
	<i>Caution: BIOHAZARD</i> Protective measures must be used in dealing with biologically hazardous materials such as carcinogenic reagents.
	USB Connection
	LED
	Disposal of your old appliance <ol style="list-style-type: none"> 1. When this crossed-out wheeled bin symbol is attached to a product, it means the product is covered by the European Directive 2012/19/EU. 2. All electrical and electronic products should be disposed of separately from the municipal waste stream via designated collection facilities appointed by the government or the local authorities. 3. The correct disposal of your old appliance will help prevent potential negative consequences for the environment and human health. 4. For more detailed information about disposal of your old appliance, please contact your city office, waste disposal service or visit our web-site, www.nanoentek.com.
	This product conforms to UL 61010-1, CAN/CSA C22.2 No.61010-1 "Safety Requirements for Electrical Equipment for Measurement, Control, and Laboratory Use, Part I: General Requirements." Instruments bearing the TUV symbol are certified by TUV Product Services to be in conformance with the applicable safety standard for the US and Canada.

Warnings

1. After using device, please turn off main power.

If not, it may cause malfunction or may reduce product life.

2. When turning off the device, be sure to lock the device with Lock button.

If not, it may cause mechanical problem or error message when device is booting.

Item	Warning
Battery inside device	<ul style="list-style-type: none"> • Risk of explosion if battery is replaced incorrectly. • This battery is not replaceable by user. Refer to an authorized service person.
Cover	<ul style="list-style-type: none"> • Do not remove cover or disassemble case. There are no adjustable components inside the instrument. • If a malfunction is found, refer to an authorized service person.
Manual	<ul style="list-style-type: none"> • Do not attempt to service the equipment. • This manual is only available in English. • Failure to heed warnings may result in injury to service provider or operator.
Sample handling	<ul style="list-style-type: none"> • Wear personal protective equipment during sampling and testing. • Sample may contain infectious or bio-hazardous agents. • Use capped tubes and lint free wipes. Lint free wipes to be used one time and discarded.
Waste	<ul style="list-style-type: none"> • After using AccuChip, appropriately dispose as bio-hazardous waste. • Do not reuse AccuChip.

Technical Support

Visit the our Website at www.nanoentek.com for :



- Technical resources, including manuals, FAQs, etc.
- Technical support contact information
- Additional product information and special offers.

For more information or technical assistance, please call or email.

NanoEntek

NanoEntek, Inc.

851-14, Seohaero-ro, Paltan-myeon, Hwaseong-si, Gyeonggi-do, 18531, Korea

Tel. +82-2-6220-7940

Fax. +82-2-6220-7999

Email

sales@nanoentek.com

Website

www.nanoentek.com

ADAM MC2

NESMU-AMC2-001E (V.0.3)



NanoEntek, Inc.

851-14, Seohae-ro, Paltan-myeon, Hwaseong-si, Gyeonggi-do, 18531, Korea

Tel. +82-2-6220-7940

Fax. +82-2-6220-7999

Email

sales@nanoentek.com

Website

www.nanoentek.com